

# Swing Gate Requirements

Only install the operator on gates used for vehicular traffic. Be sure to direct pedestrians to a separate entry and exit. Refer to the illustrations. The gate site must be designed so persons do not come in contact with the vehicular gate while it is moving. Signs must be posted to warn pedestrians to stay clear of the gate's entire travel path. A separate pedestrian entry/exit must be clearly visible and promote pedestrian usage.

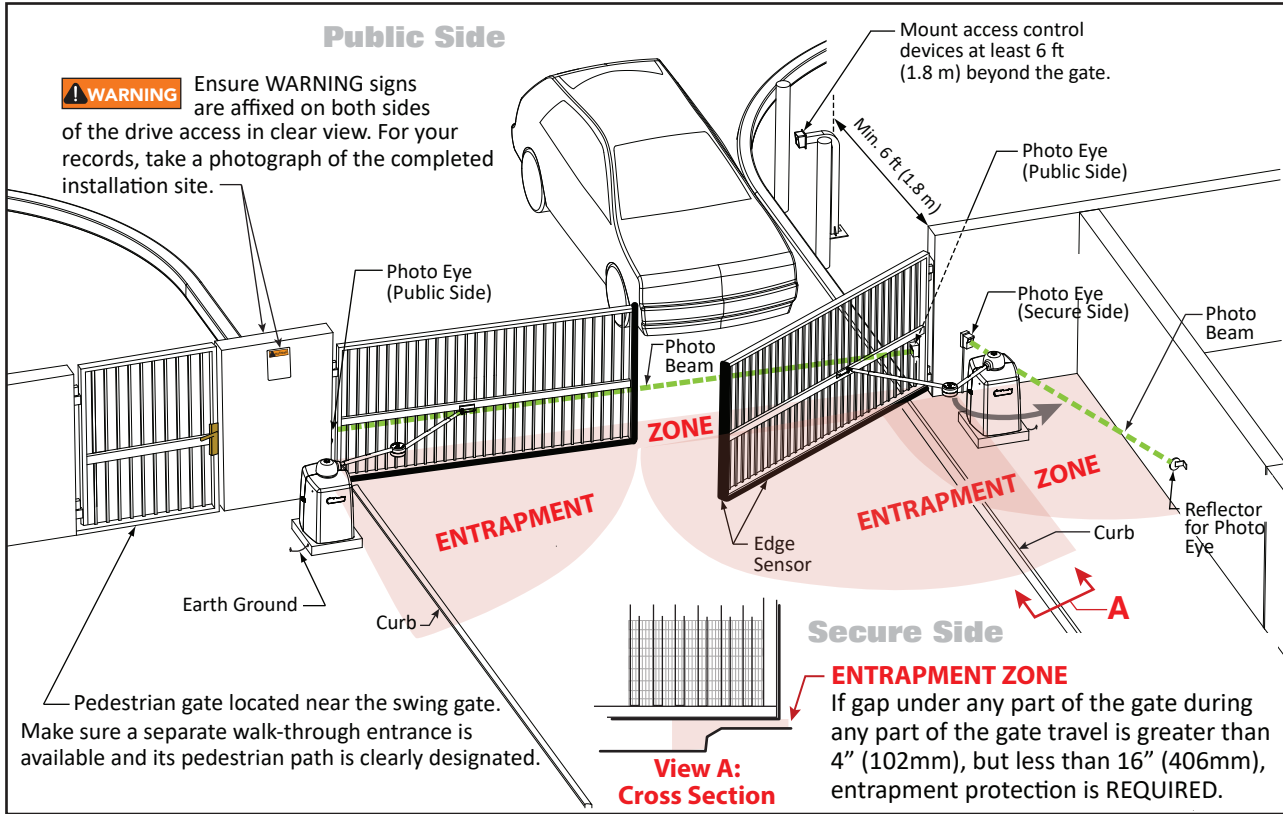

## Hinge Mount Location: Entrapment Considerations

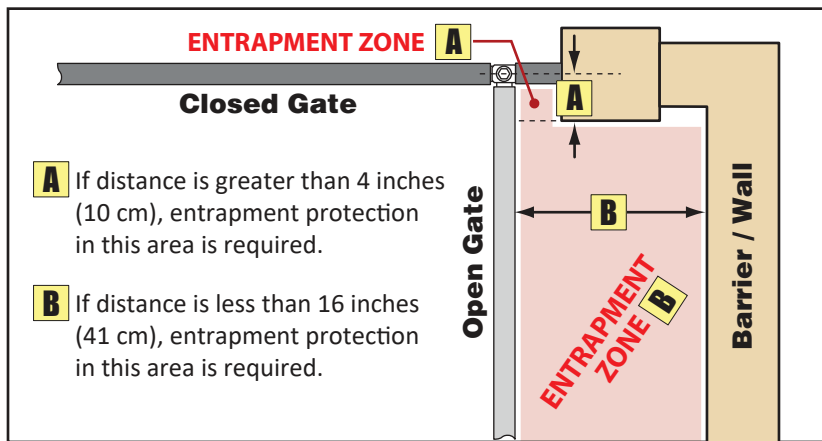

## Slide Gate Requirements

Only install the operator on gates used for vehicular traffic. Be sure to direct pedestrians to a separate entry and exit. Refer to the illustrations. The gate site must be designed so persons do not come in contact with the vehicular gate while it is moving. Signs must be posted to warn pedestrians to stay clear of the gate's entire travel path. A separate pedestrian entry/exit must be clearly visible and promote pedestrian usage.

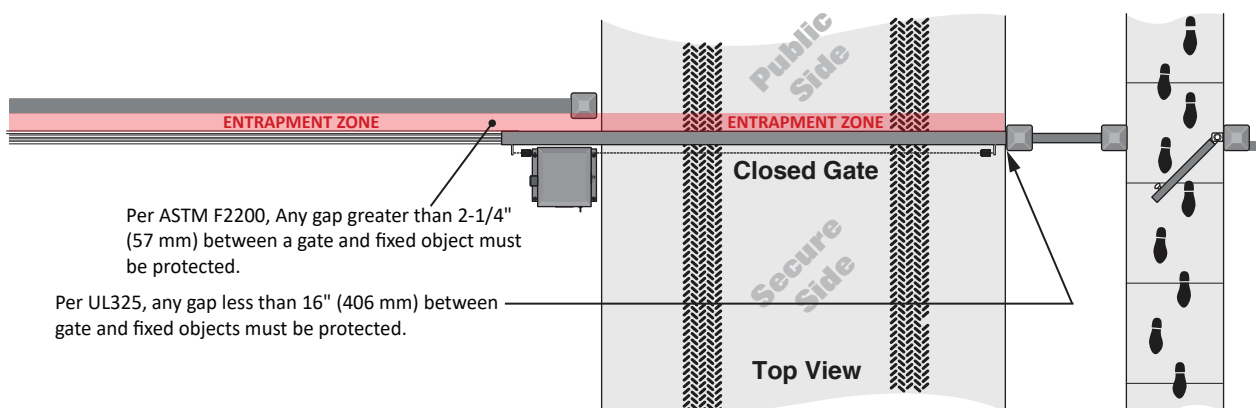
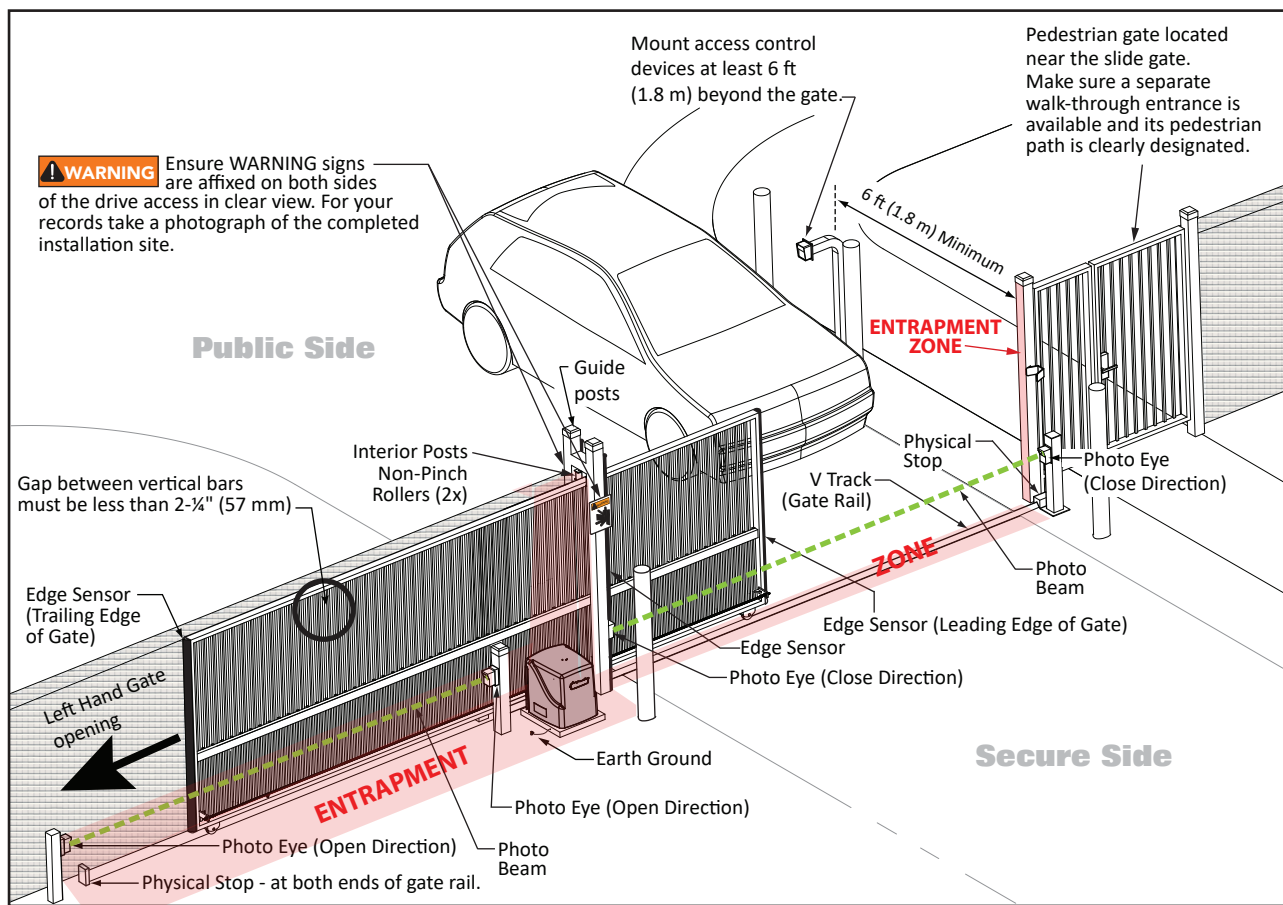

## Base of Swing & Slide Gates:

Gates must have smooth bottom edges; no protrusions should exist. If gate hardware or sensors protrude, they must have smooth surfaces free of any sharp cutting edges that do not exceed 1/2 inch (13 mm) beyond the base of the gate.

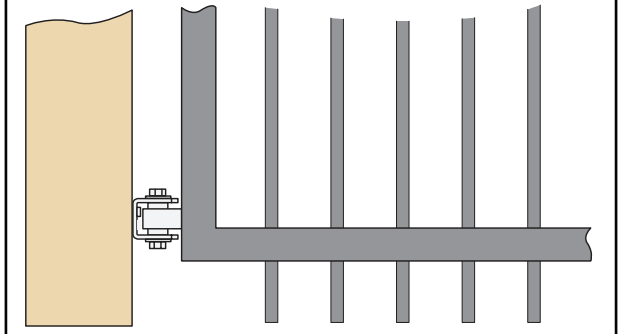
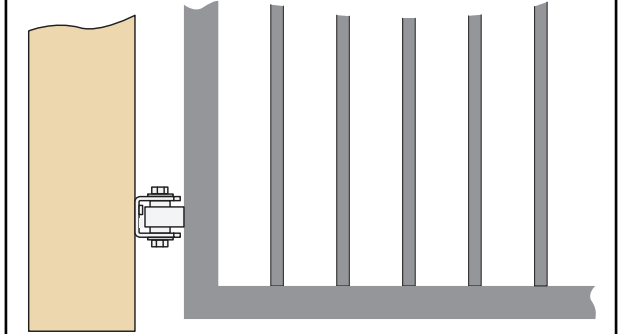

## Compliant Openings: Picket Spacing

Gap between vertical bars must be less than 2-1/4 inches (57 mm) up to a height of 6 ft (1.8 m) above grade.

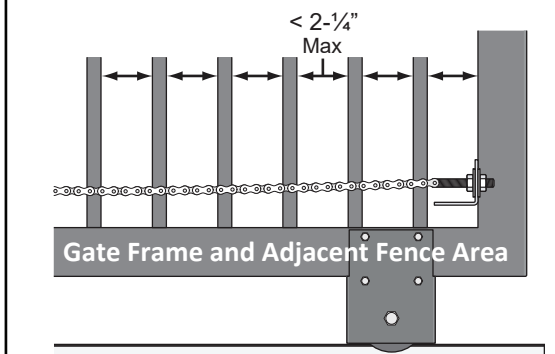

## Screened Mesh

In the illustration below, the gap between vertical bars is non-compliant. It poses a safety hazard if it is 2-1/4 inches (57 mm) or wider.

A screened mesh has been added to comply with ASTM F2200 and UL325 gate standards.

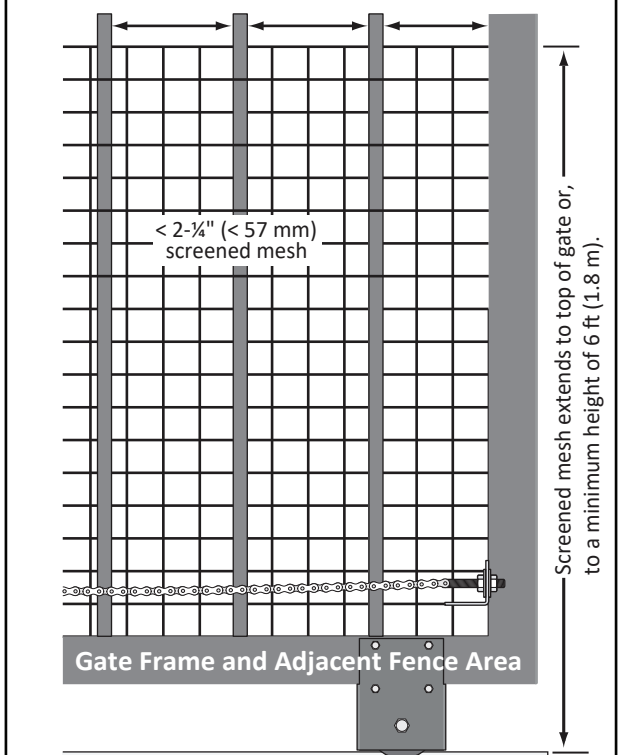

All openings of a horizontal slide gate are guarded or screened from the bottom of the gate to the top of the gate or to a minimum of 6 ft (1.8 m) above the ground to prevent a 2-1/4 inch (57 mm) diameter sphere from passing through the openings anywhere in the gate and in that portion of the adjacent fence that the gate covers in the open position.

It is the owner's and user's responsibility to be aware of potential hazards associated with an automated vehicular gate system and take appropriate steps to reduce the risk of injury.

Be sure to read the Important Safety Information found in your gate operator's manual as it provides more details and safety considerations than can be supplied in this brochure.

**NOTICE:** The design and construction of automated gates for vehicular traffic must comply with certain safety standards and local codes. The illustrations and callouts in this brochure show the basic for gate system compliance.

## A MOVING GATE CAN CAUSE SERIOUS INJURY OR DEATH!

- Make sure your gate operator is grounded.
- If your operator is equipped with an Emergency Stop Switch, ask the installer where the Emergency Stop Switch is located and cycle the gate once or twice to test it.
- Learn how to turn power ON and OFF and manually open and close the gate.
- Inspect the entrapment protection devices. Ask your installer to perform tests and show you that they are working properly.

This brochure highlights industry safety standards and identifies entrapment protection devices that need to be in place to avoid serious injury or death. Before the installer leaves the site, take a few minutes to inspect and test your gate system.

Automated vehicular gate systems provide user convenience and security. However, because these machines can produce high levels of force, it is imperative that you understand how proper site design, installation and maintenance reduce potential hazards associated with gates and automatic gate operators.

## BE SAFE!

### HORIZONTAL SLIDE GATE SYSTEM:

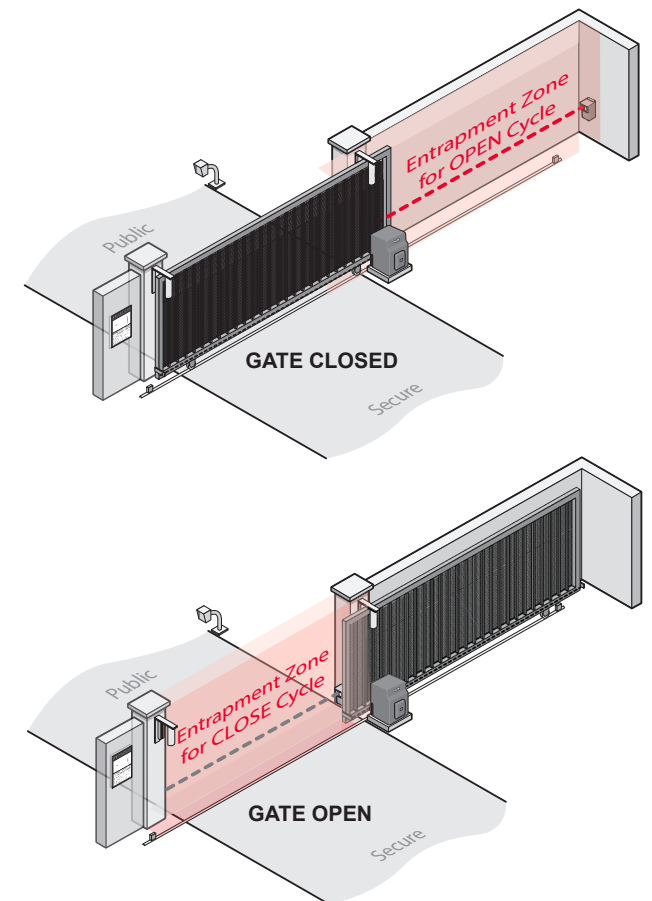

### SWING GATE SYSTEM:

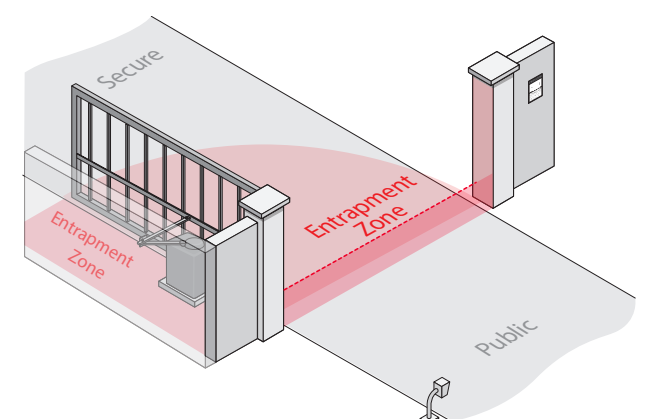

**MORE INFORMATION WEBSITES:**  
 DASMA: [www.dasma.com](http://www.dasma.com)  
 UL325: [www.ul.com](http://www.ul.com)  
 Automated Vehicular Gate Standards, ASTM F2200: [www.astm.org](http://www.astm.org)

**DISCLAIMER:** This brochure cannot cover all possible site situations or compliance issues. Be sure to read your gate operator's manual, follow manufacturer's requirements, and consult with your qualified installer for additional information.

© 2021 DASMA  
 08/28/2021

- Check the gate hardware on a regular basis.
  - Tighten any loose fasteners and replace any worn or damaged parts. A smooth running gate prolongs the life of your gate operator.
  - Before the qualified installer leaves the site, test all sensing features) to make sure the gate stops and/or reverses upon sensing an object.
  - Make sure you receive instructions on all operational functions of the gate operator. Learn how to reset the gate operator, turn on and off power, and manually operate the gate.
  - Check that the gate is level. Manually open and close the gate to make sure it travels smoothly. (Refer to the gate operator's manual to learn how to turn off power and move the gate by hand.)
  - Check all entrapment protection devices in accordance with the manufacturer's recommended maintenance schedule.
  - Follow the maintenance schedule recommended by the manufacturer and ask your qualified installer about a service agreement. On a regular basis:
- INSTALLATION AND MAINTENANCE**

### PRECAUTIONS FOR GATE SYSTEMS:

#### ENTRAPMENT ZONE HAZARDS:

Body parts may become entrapped between a gate and a stationary object when the gate moves, which can result in serious injury or death. **Make sure pedestrians stay clear of the gate path and areas where gate motion is close to stationary objects.**

#### PINCH POINT HAZARDS:

- In open roller slide gates, severe injury can occur when hands and fingers get caught in the slide gate rollers. Feet can be injured between the bottom of the gate and bottom rollers. **Make sure roller guards are installed to cover these pinch points.**
- A swing gate's opening mechanism may have arms that can overlap with a scissoring effect, which can result in serious injury. **Make sure pedestrians stay clear of the gate path and the opening mechanism, especially when the gate is in motion.**

#### CRUSH HAZARDS:

In picket gates, body parts positioned between the bars, when the gate begins to move, can result in serious injury or death. **Make sure openings are covered or screened and gaps are filled to prevent persons from reaching through, and/or passing through, the gate.**

#### SAFETY CHECKLIST:

- ☑ Automated gates are for vehicular use only; provide and maintain walkways and signs to direct pedestrians to a separate walk-through entrance.
- ☑ Clearly display **WARNING SIGNS** on both sides of the gate in clear view.
- ☑ Never let children operate or play with gate controls.
- ☑ Keep all remote controls, especially radio transmitters, away from children. **DO NOT** allow children to play on or around the gate or gate operator.
- ☑ Make sure all access control devices are mounted at least 6 feet (1.8 m) away from any moving parts. Create a safe design where a person need NOT reach over, under, through or around the gate to operate the access controls.

This brochure accompanies your Automated Vehicular Gate System and provides an overview of safety and general design considerations that should be implemented at your site.

Its purpose is to provide guidance and help familiarize you with gate and gate operator safety standards and requirements.

Review this brochure carefully and keep it for reference. If you have any questions, consult with your qualified installer for additional information.

**NOTICE:** All external entrapment protection devices must be monitored for presence. If a fault occurs, the gate operator will not function unless a continuous pressure activation device is being used.

## Gate System Safety An Automatic Decision



## SAFETY ◆ GUIDE



## BE AWARE:

Make sure your gate system is installed and maintained according to the manufacturer's instructions. Make sure your installer adheres to UL 325 and ASTM F2200 standards discussed in this brochure and in the Important Safety Instructions found in the operator's manual.

## DO:

**REVIEW** the illustrations found in this brochure for more information and safety requirements.

**OPERATE** your gate system **ONLY** when all necessary entrapment protection devices are connected and working properly. Examples of these devices include:

- Edge sensors
- Photoelectric sensors (e.g. photo eyes)
- Proper adjustment of the inherent sensing system

**FOLLOW** ASTM F2200 standard for automated gates. Where applicable, these include the following:

#### ALL GATE TYPES:

- No protrusions along the bottom of the gate.
- Fall-over protection to prevent the gate from falling when gate is detached from supporting hardware.

#### SLIDE GATES:

- Covers for all exposed weight bearing rollers and pinch points that exist less than 8 feet (2.5 m) above grade.
- Physical gate stops to avoid over-travel in both directions.
- Protective screen mesh to guard openings from the gate's base support to a minimum height of 6 feet (1.8 m) above the ground. This must prevent a sphere of 2-¼ inches (57 mm) from passing through any opening in the gate or adjacent fence (the portion covered in the gate's open position.) Refer to the illustrations.
- A gap (measured horizontally, parallel to the roadway) between a fixed stationary object nearest the roadway and the gate frame shall not exceed 2-¼ inches (57 mm) when opened or closed.