

StrongArm® M30/M50

StrongArm M30 CE

StrongArm M50 CE



Crash-rated barrier arm

EN - Programming and operations manual

IMPORTANT - These instructions apply only to the CE models.

StrongArm: M30 CE & M50 CE

Table of contents 2

Contact Information 3

Introduction..... 4

Safety Information 6

Power 16

Arm Position Sensor - Limit Switches..... 19

Control Panel Overview..... 23

Display & Menu Options 24

User Menu 28

Installer Menu 33

STC Inputs & Wiring 44

Dual Gate Systems..... 64

Troubleshooting 71

Hand Pump Operation..... 83

General Maintenance 84

Reference Section..... 89

Appendix A - Wiring Diagrams..... 90

Appendix B - Wire Sizing & Runs 95

Appendix C - Vehicle Loop Layout 98

Checklist - Post Installation 103

Warranty 105

Specifications 106

CONTACT INFORMATION

Visit <https://support.hysecurity.com/hc/en-us> for installation manuals, replacement part instructions, part diagrams and more. Qualified HySecurity distributors are experienced and trained to assist in resolving installation problems.

For the name of a qualified distributor near you, call HySecurity at 800-321-9947. *Before contacting your distributor or HySecurity Technical Support, obtain the serial number of your operator.



Figure 1. HySecurity M30
StrongArm

StrongArm M30 Components

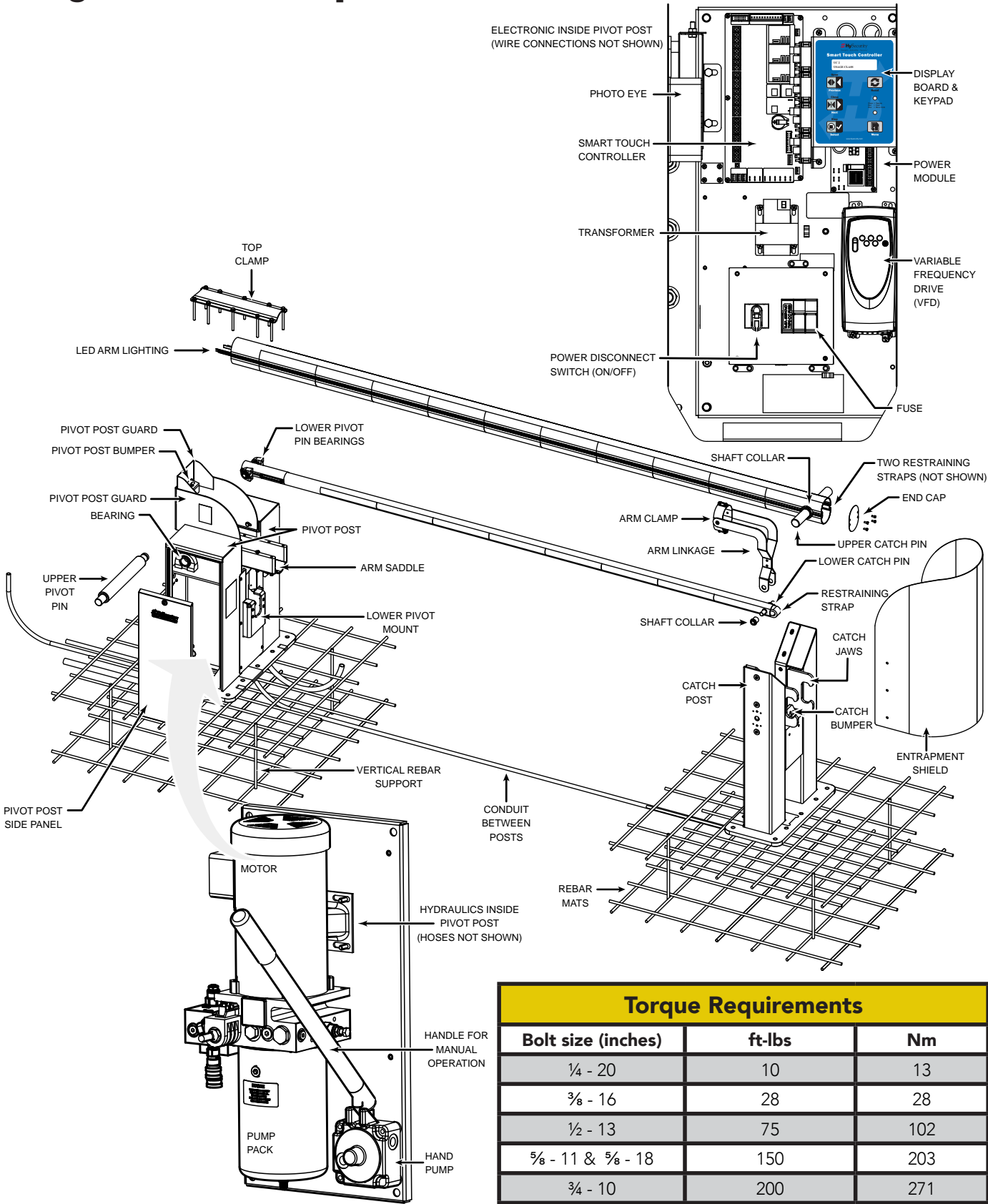

Torque Requirements		
Bolt size (inches)	ft-lbs	Nm
1/4 - 20	10	13
3/8 - 16	28	28
1/2 - 13	75	102
5/8 - 11 & 5/8 - 18	150	203
3/4 - 10	200	271

StrongArm M50 Components

The same call outs used on the StrongArm M30 match the StrongArm M50 components. To review the exploded parts and terminology, refer to the previous page. The StrongArm M50 differs in the size and strength of its components.

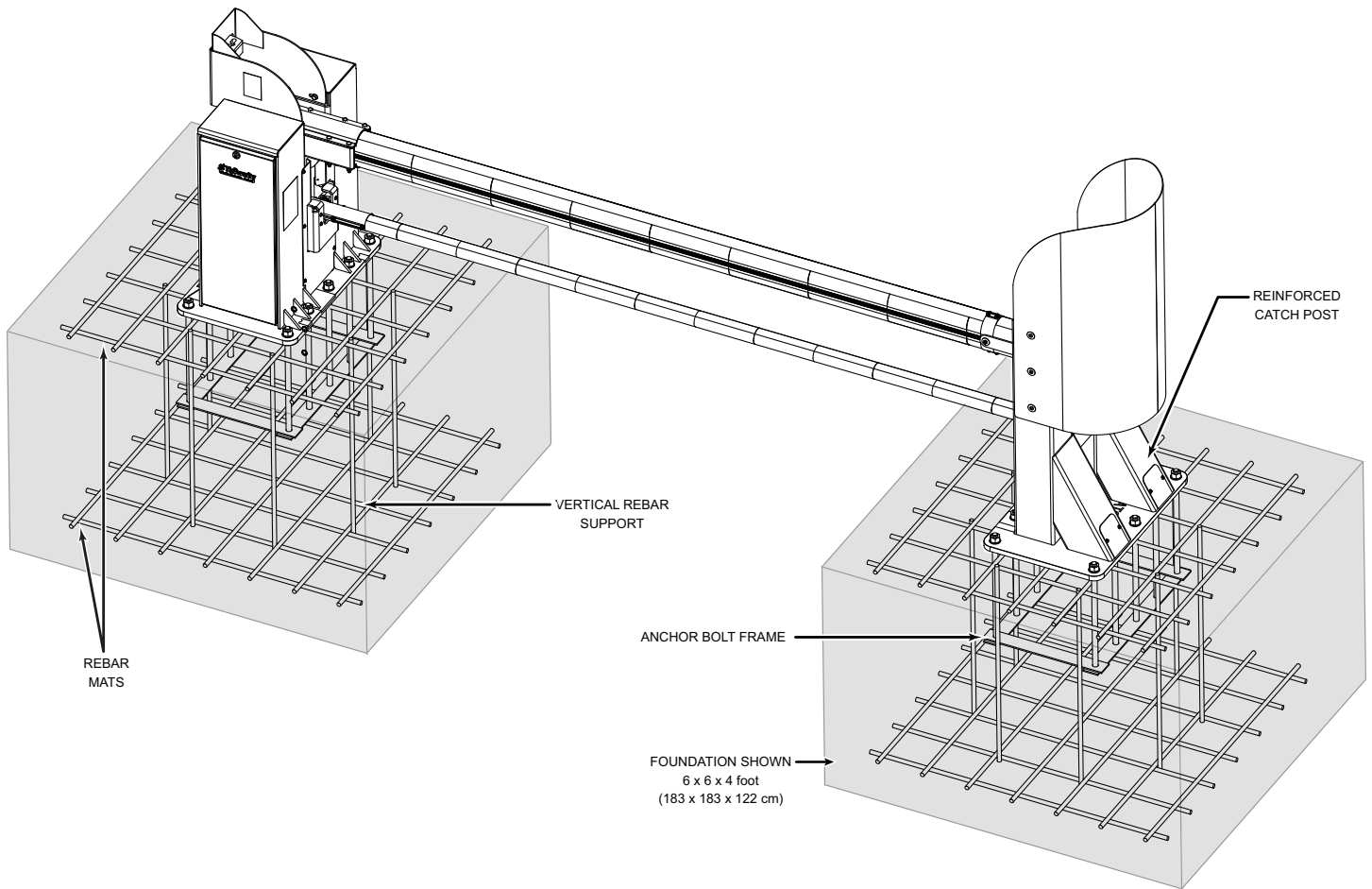

Torque Requirements		
Bolt size (inches)	ft-lbs	Nm
1/4 - 20	10	13
3/8 - 16	28	28
1/2 - 13	75	102
5/8 - 11	120	203
5/8 - 18	150	203
1 - 8	150	203

SAFETY MESSAGES

The safety messages below inform you about potential hazards that can result in injury. Safety messages specifically address level of exposure to operator and are preceded by one of four words: **DANGER, WARNING, CAUTION** or **NOTICE**.

 **DANGER**

Indicates a hazardous situation which, if not avoided, **WILL** result in **DEATH** or **SERIOUS INJURY**.

 **WARNING**

Indicates a hazardous situation which, if not avoided, **COULD** result in **DEATH** or **SERIOUS INJURY**.

 **CAUTION**





Indicates a hazardous situation which, if not avoided, **COULD** result in **MINOR** or **MODERATE INJURY**.

NOTICE

Addresses practices not related to personal injury. Indicates damage to equipment is probable if the hazardous situation is not avoided.

COMMON INDUSTRIAL SYMBOLS

These international safety symbols may appear on product or in its literature to alert of potential personal injury hazards. Obey all safety messages that follow these symbols to avoid possible injury or death.

Symbol	Safety Hazard
	Attention - Take Notice
	Danger - Keep Away
	Entrapment Zone
	Possible Pinch Point

IMPORTANT SAFETY INSTRUCTIONS

Hazards, associated with automatic gates, can be reduced with proper site design, installation, and use. Installers, maintenance crews, and owners/users must read and follow the safety requirements found in HySecurity® product manuals.



It is important that only qualified installers handle installation of HySecurity Gate vehicular gate operators. A “qualified” installer has one of the following:



1. A minimum of three years experience installing similar equipment.
2. Proof of attending a HySecurity Technical Training seminar within the past three years.
3. Significant manufacturer endorsements of technical aptitude in gate operator installation and operation.

Underwriter Laboratories (UL) and the American Society for Testing and Materials (ASTM) are responsible for current safety standards and regulations regarding gate operators and automated gates. All aspects of gate installation must comply with the appropriate safety standard. For the most up-to-date ASTM F2200 Gate and Fence Standards, refer to www.astm.org. For UL 325 Safety Standard, refer to www.ul.com. Consult local government agencies for up-to-date rules and regulations as certain municipalities have established licensing, codes or regulations that regulate automated gate system design and installation.

GENERAL SAFETY INFORMATION

A gate operator is only a component in a gate system. The other parts of the gate system can include the gate, the external safety sensors, access controls, and vehicle detectors. To have a gate system that provides for safety, security, and reliable operation it is essential these components operate together as a system. It is the responsibility of the system designer and/or installer to ensure any safety or operational issues have been addressed.

WARNING!

To reduce the risk of injury or death:

1. **READ AND FOLLOW ALL INSTRUCTIONS.**
2. Never let children operate or play with gate controls. Keep the remote control away from children.
3. Always keep people and objects away from the barrier arm. **NO ONE SHOULD CROSS THE PATH OF THE MOVING ARM.**
4. Test the gate operator monthly. The barrier arm **MUST** reverse on contact with a rigid object or stop when an object activates the non-contact sensors. After adjusting the force of travel, retest the gate operator. Failure to adjust and retest the gate operator properly can increase the risk of injury or death.
5. **KEEP BARRIER ARM GATES PROPERLY MAINTAINED.** Read the installation and operating manual. Have a qualified service person make repairs to gate hardware.
6. The entrance is for vehicles only. Pedestrians must use a separate pathway that prevents contact with the barrier arm.
7. **SAVE THESE INSTRUCTIONS.**

IDENTIFYING GATE OPERATOR CATEGORY AND UL 325 USAGE CLASS

The UL 325 standard covers gate operators. Within this safety standard several Usage Classes are described that define different types of installations where gate operators can be applied. Some operators are restricted in their usage application. Appropriate Usage Classes are shown in the Specifications.

Class I



Class I: Barrier arm gates are NOT Intended for use in a location of one to four single family dwellings or a parking area associated with one to four single family dwellings.

Class II



Class II: Intended for use in a commercial location or building such as a multi-family housing units (five or more single family units) hotels, garages, retail stores or other buildings servicing general public.

Class III

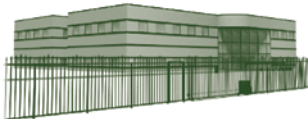

Class III: Intended for use in an industrial location or building such as factories or loading docks or other locations not accessible by the general public.

Class IV



Class IV: Intended for use in guarded industrial locations or buildings such as an airport security area or other restricted access location, not servicing general public, in which access is monitored by security personnel or via closed circuitry.

INSTALLER'S RESPONSIBILITY

- Study all of the accompanying product literature prior to installing, operating, or maintaining the StrongArm M30/M50 Crash-rated Barrier Arm. Take the time required to allow for site provisions, proper installation and alignment of the posts and crash barrier arm, and verification of a fully functional operator. A proper installation will improve user safety, reduce maintenance, guarantee longest system life, and ensure customer satisfaction.
- Install the StrongArm M30/M50 according to the instructions found in the installation literature. The foundations must be installed in soils (natural or controlled fill material) that are suitable for construction and foundation sub grade and approved by the site engineer prior to construction.
- Make sure to install the Crash-rated Barrier Arm on a level surface. Both pivot and catch posts must be plumb and level, and on grade with the roadway surface. Slope drainage ¼-inch per foot within 2 feet of the operator (2 cm per meter).
- Proper alignment and installation of the pivot and catch posts is critical to the operation of the Crash-rated Barrier Arm. Use the Anchor Cage Templates supplied and take accurate measurements to determine the proper distance between pivot and catch posts.
- Vehicle detector loop size and placement are critical to ensure the proper and safe function of the StrongArm M30/M50. Review and follow the loop plan drawings in this manual. Refer to "Appendix C - Vehicle Loop Design and Layout" on page 92.
- Provide a separate pedestrian walk-through entrance nearby. Make certain a clear pedestrian path is designated and signs direct pedestrians toward the walk-through entrance to ensure their safety. The automated Crash-rated Barrier Arm entry is for vehicle use only. No one should walk under the path of a moving barrier arm.

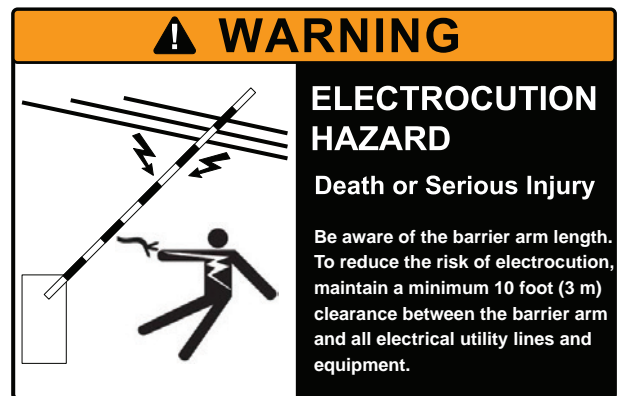

- All exposed pinch points must be guarded. To reduce the risk of entrapment, the StrongArm M30/M50 must be installed so that appropriate clearance (minimum 2 feet, 61 cm) exists between the operator posts and adjacent structures both when opening and closing.
- The Crash-rated Barrier Arm must not be modified in any way that creates a risk of entrapment or a possibility that some portion of the moving arm could snag onto the clothing of a pedestrian that happened to be nearby. Specifically prohibited are any chains or other material attached to the crash barrier arm that may create such a hazard. Do not remove the guards, entrapment shield, or lower arm. Refer to StrongArm M30/M50 Components.
- The barrier arm operator must be properly grounded, and the incoming power voltage must match the voltage and phase labels found on the junction box and motor.
- Be aware of the length of the M30/M50 Arm. Safeguard against any possible contact between the M30/M50 Arm and overhead power or utility cables and wires.
- Do not physically disable the warning buzzer and NEVER disconnect or cut its wires. It provides an alert that the M30/M50 Arm is about to move. Disabling the warning buzzer may increase the risk of death or serious injury.
- Demonstrate the safety features and operation of the barrier arm operator to the end user, and clearly explain and demonstrate the consequences of removing or defeating any of the safety features.

OWNER/USER RESPONSIBILITY

As the owner/user, you are responsible for the correct and safe installation, operation and maintenance of the StrongArm M30/M50 Crash-rated Barrier Arm. It is of the utmost importance that you read and follow the specific instructions and precautions found in the "Safety Information" addressed in this manual.

NOTICE

For installations outside the United States, make sure that you follow the applicable international, regional, and local safety standards.

- The automatic StrongArm M30/M50 Crash-rated Barrier Arm is for vehicular use only; provide and maintain walkways and signs to direct pedestrians to a separate walk-through entrance.
- The WARNING labels supplied with the StrongArm M30/M50 must remain installed and clearly visible on both sides of the barrier arms.
- Do not physically disable the warning buzzer and NEVER disconnect or cut its wires. Disabling the warning buzzer may increase the risk of death or serious injury.
- An automatic M30/M50 Arm can start at any time without warning; always keep people away from the barrier arm area.
- Never let children operate or play with StrongArm M30/M50 controls. Keep all remote controls, especially radio transmitters, away from children. Do not allow children to play on or around the barrier arms or posts.
- Learn how to turn the power on and off. Learn how to manually operate the StrongArm M30/M50.
- Never disconnect the built-in photo eye. Test the photo eye during regularly scheduled maintenance.

- Do not remove lighting, traffic signal wiring, bumpers or any other safety features.
- Test the barrier arm monthly. Specifically, test the photo eye function. The StrongArm M30/M50 must stop or reverse when an object blocks the photo eye beam.

Annually, or in the event of any damage, have an authorized Crash-rated Barrier Arm installer routinely inspect all aspects of the StrongArm M30/M50 hardware, restraining straps, and software. Have a qualified service person make repairs to Crash-rated Barrier Arm hardware to keep the StrongArm M30/M50 running smoothly.

HAZARDOUS MATERIALS AND PROPER DISPOSAL

Be aware of the international, federal, and local codes in your area and how best to handle hazardous waste materials.

The pump pack fluid, found in all hydraulic HySecurity operators, can be recycled. Gear oil, found in HySecurity electromechanical gate operators, can also be recycled. If the fluids are mixed or contaminated with any solvents or other chemicals, they become hazardous waste. Hazardous waste requirements for storage and disposal must be followed.

The disposal of the barrier and all accessories shall be performed according to the local regulations.

CAUTION

If the gate operator has a battery backup system, the batteries contain materials that are considered hazardous to the environment. Proper disposal of the battery is required by federal law. In the U.S.A., refer to federal EPA guidelines for proper hazardous waste disposal.

HySecurity Vertical Barrier Arm Safety and Traffic Control

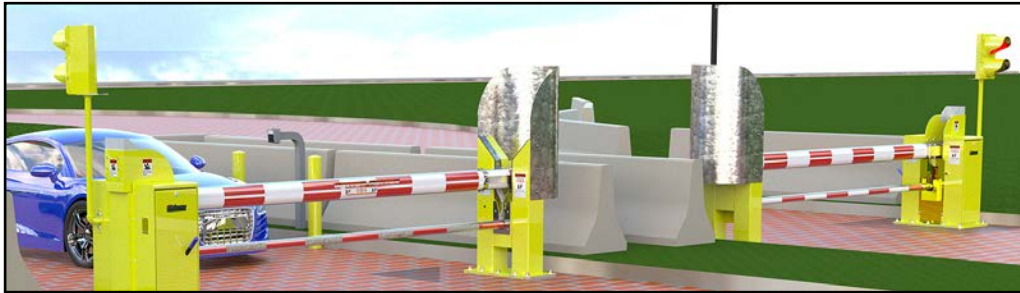

ARM INSTALLATION

Do not install the operator where arm moves within 16 inches of a rigid object or within 10 feet of high power wires when the barrier arm is raised.

TRAFFIC SPEED

The acceptable speed through the gate entry or exit is 5 MPH. To help regulate traffic, speed limit signs, hazard stripes, and speed bumps may be utilized.

USER RESPONSIBILITY

The user is responsible for gate safety and should familiarize themselves with all aspects of gate operation, including:

- hardware operation
- entrapment protection
- electrical and mechanical safety
- arm reversing functions and testing
- edge contact sensors
- photoelectric eye sensors
- gate operator accessories (alarms, radio, etc.)



WARNINGS FOR BARRIER ARM SAFETY

- **The gate system should be installed so that the person operating the gate can observe the entire movement of barrier arm.**
- **The gate operator controls should be located at least 6 feet away from the barrier arm to prevent controls being used by an operator while in contact with the barrier arm.**
- **Emergency access controls must be protected from unauthorized use and placed so that emergency personnel can access them.**
- **Keep all persons and children away from the gate entry/exit and all hazard areas.**
- **Arm barriers are meant ONLY for vehicles; bicycles and motorcycles are NOT permitted through the barrier arm gate system.**
- **A separate and clearly marked entry/exit must be provided for pedestrian traffic to prevent contact with the barrier arm.**
- **All electrical connections must be made in accordance with local electrical codes.**
- **To avoid unauthorized use of the controls, install security features on the barrier arm operator, such as a lock.**
- **When manually operating gate, ensure that no vehicles or pedestrians are in the gate area.**

HySecurity Vertical Barrier Arm Safety and Traffic Control

High levels of force are generated by moving traffic barrier arms. Ensure warning signs and safety devices are properly installed and operated to address the following hazards:

- Pinch points
- Overhead power lines
- Entrapment areas
- Traffic speed

Refer to the list below for safety features available for the installation of a barrier arm gate system. Refer to the drawings on the next page for a visual reference of these features.

⚠ WARNING!

The primary hazard for barrier arms is the barrier arm striking a person as it is lowered, so any measures to prevent persons from entering the area under the arm will be most effective in ensuring safety. A non-contact photo-eye sensor (see below) is recommended for maximum protection as it will prevent the arm lowering if the beam is interrupted by the presence of a person under the arm.

1 Non-Contact Sensor (Photo Eye)

Located directly below the arm, this sensor will minimize the potential for a barrier arm to impact a vehicle not sensed by a ground loop.

2 Loop Sensor

Loop sensors sense the presence of moving vehicles **ONLY** and prevents the barrier arm from impacting vehicular traffic. Configuration and placement depends on application. Loops do not sense persons.

3 Traffic Light

Traffic lights help control traffic flow through the gate.

4 Separate Pedestrian Walkway

A pedestrian walkway separate from gate entry is **REQUIRED**, and serves to prevent pedestrians from coming into contact with the arm.

5 LED Lights on Barrier Arm

Arm mounted LED lights allow the arm and its position to be easily seen in dark environments.

6 Speed Bump

A speed bump may help regulate traffic speed through the gate.

7 Pedestrian Warning and Hazard Stripes

This warning indicates pedestrians are not allowed to enter through the gate where they may come into contact with the barrier arm. Warnings should be positioned to be seen from both sides of the gate.

8 Arm Warning Sign (Both Sides of Arm)

This warning indicates the hazards of standing in the way of a barrier arm and should be applied to both sides of the arm.

9 Speed Limit Sign

A speed limit sign may help regulate traffic speed through the gate opening.

10 Gate Operator Warning Sign

This warning indicates the hazards of standing in the way of a barrier arm and should be applied to both sides of the gate operator chassis so it is visible to traffic in both directions.

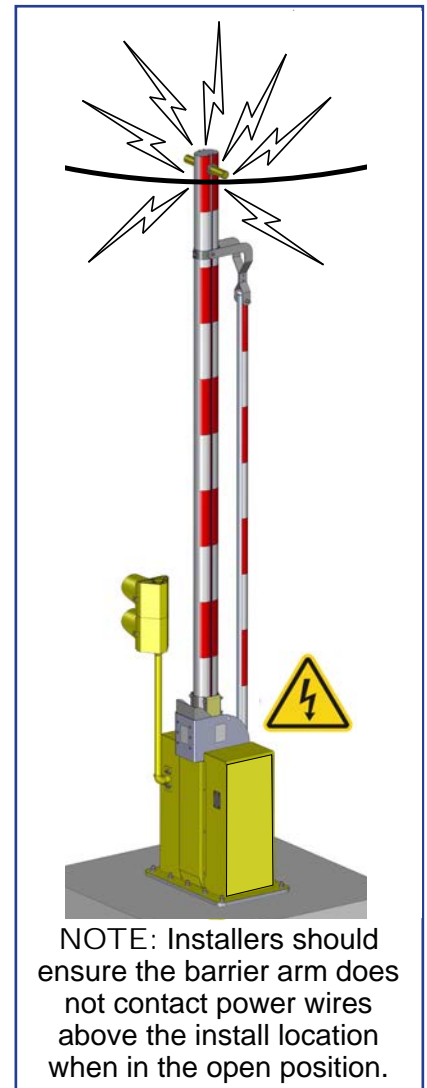

NOTE: Installers should ensure the barrier arm does not contact power wires above the install location when in the open position.

HySecurity Vertical Barrier Arm Safety and Traffic Control

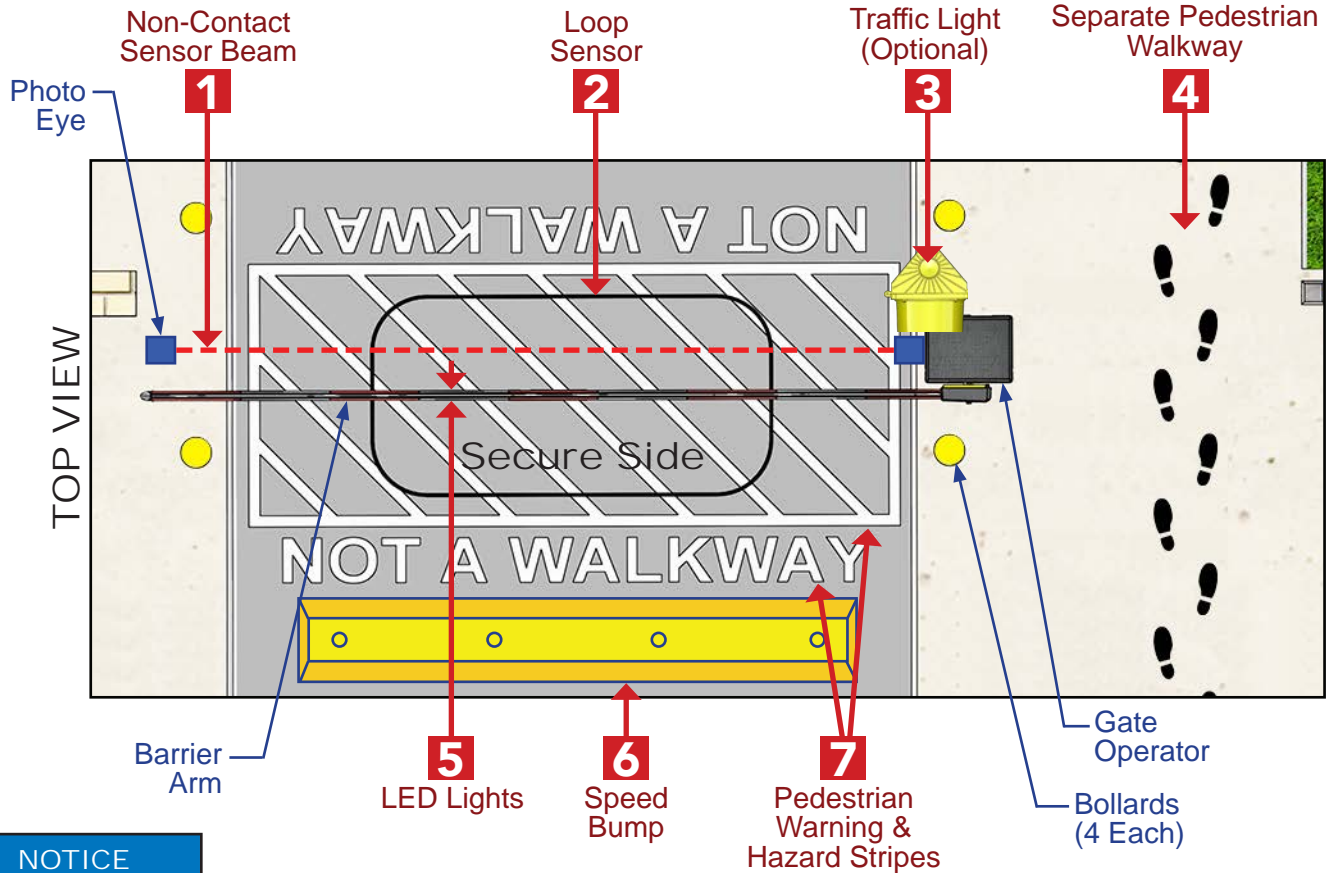

NOTICE

The barrier arm shown is a generic representation.

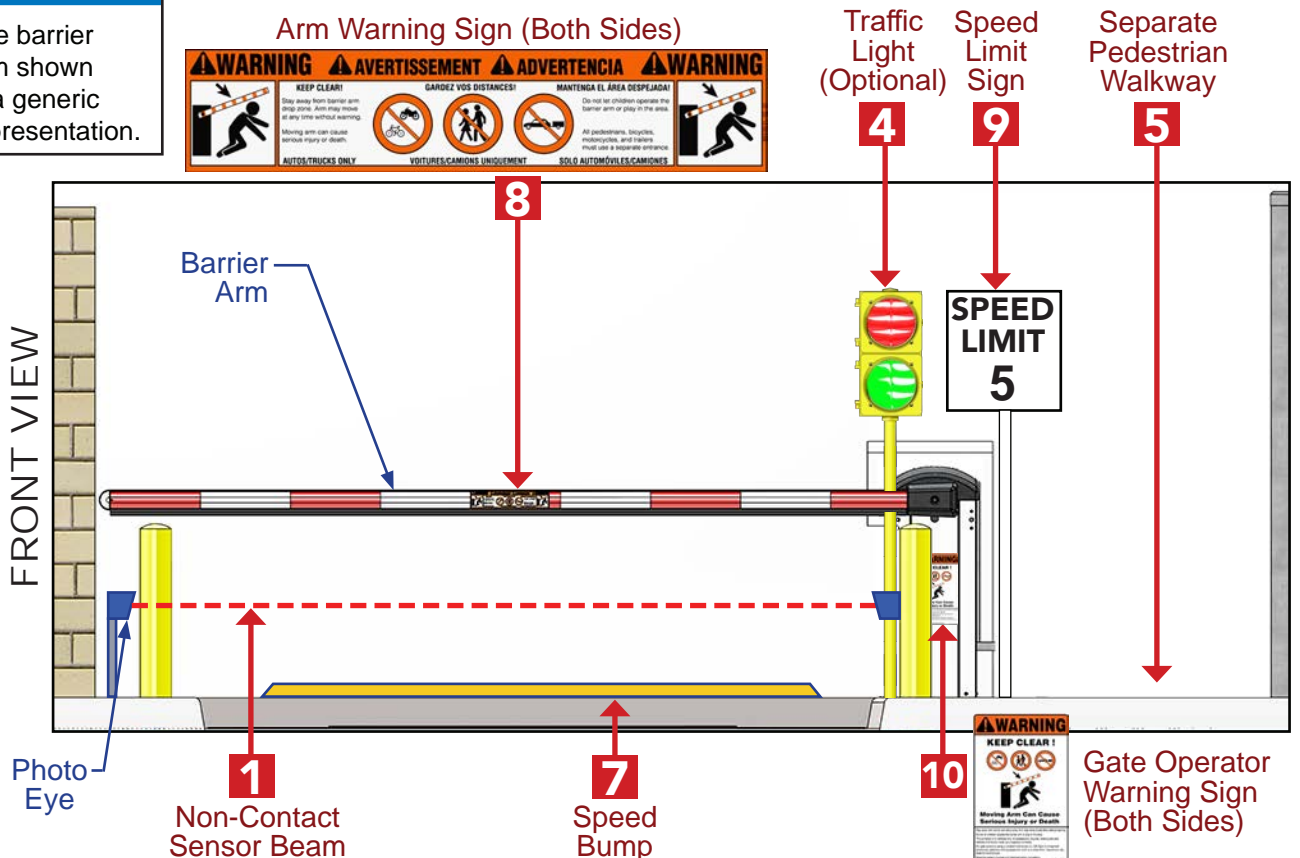

HySecurity Vertical Barrier Arm Safety and Traffic Control

The following sensors have been shown in testing to provide the best performance when installed with HySecurity operators. HySecurity supports installers who install recommended sensors. "Compatible Sensors" are still certified to meet UL 325 6th edition installation with HySecurity operators. Contact the sensor manufacturer for specific recommendations for use.



All protection sensors must have NC sensor outputs and be wired to the SENSOR COM terminal for monitoring and powering purposes. Depending on software version, the sensor becomes powered when the gate operator's motor runs or is always powered when the operator is connected to AC power.

HySecurity Compatible Sensors

	Mfg. Part #	Mfg.	Details	Hysecurity Part #
Photo Eyes (Retroreflective)	E3K-R10K4-NR	Omron	40 ft max range limit	MX000999
	NIR-50-325	EMX	45 ft max range limit	
	IRB-RET	EMX	53 ft max range limit	
	E-931-S50RRGQ	Seco-Larm	46 ft max range limit	
Photo Eyes (Thru-Beam)	IRB-MON	EMX	65 ft max range limit	MX3990
	E-960-D90GQ	Seco-Larm	90 ft max range limit	
Edge Sensors	Sentir Series	ASO Safety	Channel mount, high profile Channel mount, low profile Round, wraparound Square, wraparound	AS1502-0440-05 AS1502-0430-05 AS1501-0760 AS1501-0790
	CPT210-2U-#-T2	Miller Edge	10k resistor termination (replace # with length requirement in feet)	
Edge Sensor, Converters (10K to NC Contact)	Hy2NC	HySecurity	2-channel edge converter	MX4018
Edge, Wireless Kits	iGAZE RE Kit	Transmitter Solutions	50 ft line of sight max range limit	
	WEL-200 (kit with receiver and transmitter)	EMX	200 ft line of sight max range limit	

NOTICE

For more information on Gate Safety, visit: <https://support.hysecurity.com/hc/en-us/categories/360003177593-Safety>.

ELECTRICAL SAFETY

- Turn gate operator and all circuit breakers OFF before performing maintenance on the gate operator or making contact with output receptacles.
- Never insert any objects into output receptacles during operation. The possibility exists of electrical shock, electrocution, or death.
- Never let power wires lay in water.
- Never use damaged or worn wire when connecting equipment. Inspect for cuts in the insulation.
- Never grab or touch a live power cord or cable with wet hands. The possibility exists of electrical shock, electrocution or death.
- Always make certain that proper power has been selected for the job. See Cable Selection Chart in this manual.

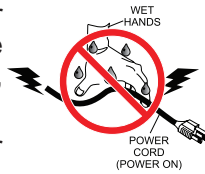
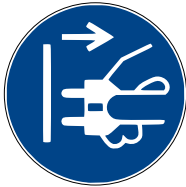

GROUNDING SAFETY

- Always make sure that electrical circuits are properly grounded to a suitable earth ground (ground rod) per the National Electrical Code (NEC) and local codes. Severe injury or death by electrocution can result from operating an ungrounded operator.
- Never use gas piping as an electrical ground.



BATTERY SAFETY

HySecurity operators use sealed Absorbed Glass Mat (AGM) batteries and HySecurity highly recommends replacing used batteries with new AGM-type batteries.

CAUTION

Batteries used with HySecurity gate operator contain materials considered hazardous to environment. Proper battery disposal is required by federal law. Refer to *Hazardous Waste Regulations* federal guidelines.

To reduce risk of fire or injury to persons:

- Observe polarity between batteries and charging circuit.
- Never mix battery sizes, types, or brands. Charging circuit on HySecurity DC operators is designed for AGM-type batteries, not flooded lead acid-type batteries.
- Exercise care in handling batteries. Be aware metal found in rings, bracelets, and keys can conduct electricity, short batteries, and cause potential injury.
- Do not open or mutilate batteries. Battery cells contain corrosive materials which may cause burns and other injuries. Material within batteries is toxic.
- Always dispose of batteries properly. Do not place batteries in fire. Battery cells may explode. Follow federal guidelines for proper disposal of hazardous waste.
- Always keep battery cables in good working condition. Repair or replace all worn cables.
- Replace batteries according to instructions found in *DC Battery Replacement*.
- Do not charge frozen battery. Battery can explode. If frozen, warm the battery to at least 61°F (16°C).



ENVIRONMENTAL SAFETY/ HAZARDOUS MATERIALS AND PROPER DISPOSAL

Decommissioning is a controlled process used to safely retire a piece of equipment that is no longer serviceable. If the equipment poses an unacceptable and unreparable safety risk due to wear or damage or is no longer cost effective to maintain (beyond life-cycle reliability) and is to be decommissioned (demolition and dismantlement), be sure to follow rules below.



- Do not pour waste or oil directly onto the ground, down a drain or into any water source.
- Contact your country's Department of Public Works or recycling agency in your area and arrange for proper disposal of any electrical components, waste or oil associated with this equipment.
- When the life cycle of this equipment is over, remove battery and bring to appropriate facility for lead reclamation. Use safety precautions when handling batteries that contain sulfuric acid.
- When the life cycle of this equipment is over, it is recommended that the frame and all other metal and plastic parts be sent to a recycling center.

Metal and plastic recycling involves the collection of metal and plastic from discarded products and its transformation into raw materials to use in manufacturing a new product.

Recyclers and manufacturers alike promote the process of recycling metal and plastic. Using a metal and plastic recycling center promotes energy cost savings.

WIND LOAD FACTORS

Wind load is not as much of a factor when considering using a barrier gate for a particular site instead of a slide or swing gate. However, when installing a barrier arm gate in a high wind area, Hysecurity suggests the following:

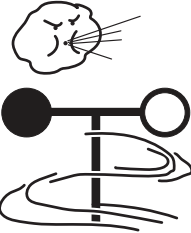

- Gate arms should be lowered during high wind conditions to avoid damage to the arm.
- Metal hardware (rather than nylon) should be used to affix the arm to the operator.

MAINTENANCE OF GATE SYSTEMS

To keep your automated gate system performing both safely and reliably it is important to ensure that the components of the system are functioning properly.

At least monthly:

- Disconnect the gate operator and manually move the barrier arm through its range of travel. Note any unusual noises or areas of binding. The arm should travel smoothly and quietly throughout its range. If it does not, contact a gate professional to correct the problem.
- Reconnect the gate operator and perform the following tests:
 - With the arm closing, block any photo eyes and/or depress any safety edges used to protect the close direction. The gate should stop and reverse direction.
 - Using a suitable obstruction in the path of the arm (a solid, immovable object), close the arm until it contacts the obstruction. The arm should stop and reverse direction.

INSTALLING THE EARTH GROUND

How to wire the operator is presented in the Installation Instructions, but detailed information about the earth and equipment ground, wiring to AC power and the availability of UPS systems are described in this section.

Supplemental documents to this section include:

- HydraSupply
- Changing Motor Connections to Match Incoming Voltage

An earth ground refers to the grounding rod and accompanying equipment ground which need to be installed to safeguard against potential electrical shock and damage to personnel and equipment.

! DANGER

The potential for lightning discharge exists with all gates, fences and gate operators. National Electric Code (NEC) - Article 250 requires a separate earth ground in addition to the required equipment ground.

HySecurity requires grounding the operator with a separate earth ground rod (or a similar device in the case of Crash-rated products) to shield the operator against electromagnetism and other electrical signals that may cause erratic operation with or damage to the Smart Touch Controller and other electrical parts. See Figure 2.

For earth grounding requirements in the U.S.A., refer to the National Fire Protection Association (NFPA) 780 - Standard for the Installation of Lightning Protection Systems. Highlights of the standard include:

- The ground rod must be UL listed copper-clad steel, solid copper, hot-dipped galvanized steel, or stainless steel. Minimum requirements: ½ inch (13 mm) diameter and 8 feet (244 cm) in length.
- The ground rod is driven into the earth (refer to local codes for proper depth requirements).
- The ground rod is electrically bonded to the chassis with a single length of un-spliced 6AWG copper wire less than 3 feet (91cm) long.

- Local jurisdictions may impose other requirements above the NEC, Article 250 and NFPA 780. Consult the local codes and regulations regarding requirements in your area.

NOTICE

Properly grounding the gate operator is critical to gate operator performance and the life of its electrical components. Use sufficient wire size during installation. If you do not ground the operator with a separate earth ground, you risk voiding the HySecurity Limited Warranty.

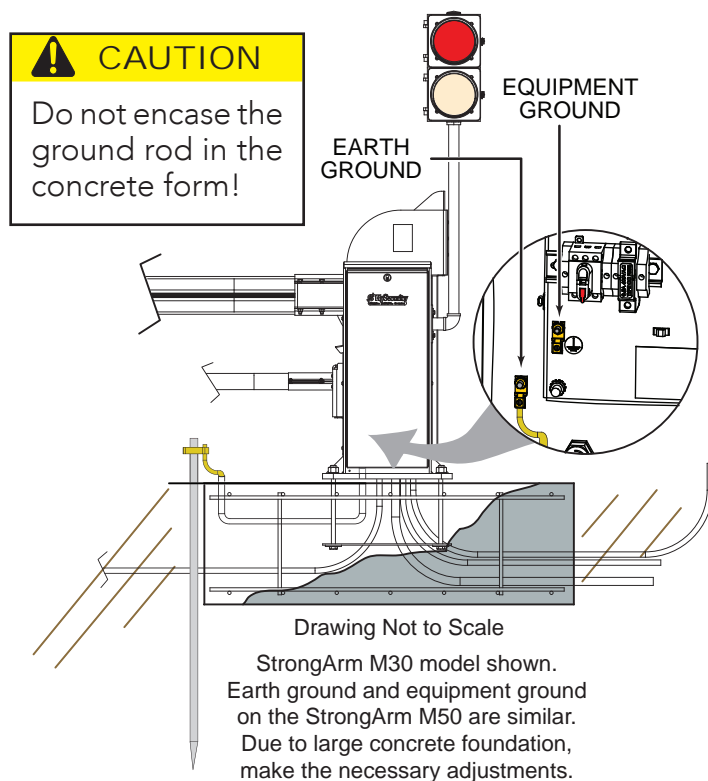

Figure 2. Installing Earth Ground

WIRING AC POWER

The StrongArm M30 and StrongArm M50 have separate *Installation Instructions* that explain how to connect to AC power. For reference purposes, the same information is provided below. See Figure 3.

The AC power disconnect switch is inside the Pivot Post (electronics side).

! DANGER

Turn OFF AC power at the source (circuit breaker panel) before accessing the wires in the StrongArm M30 or StrongArm M50. Follow facility Lock Out/Tag Out procedures. Make sure all power switches are in the OFF position. Follow all electrical code standards and regulations.

! CAUTION

Wiring of gate operators must conform to NFPA and NEC standards and comply with all local codes. When the installation is compliant and complete, turn on AC power at the source and power module.

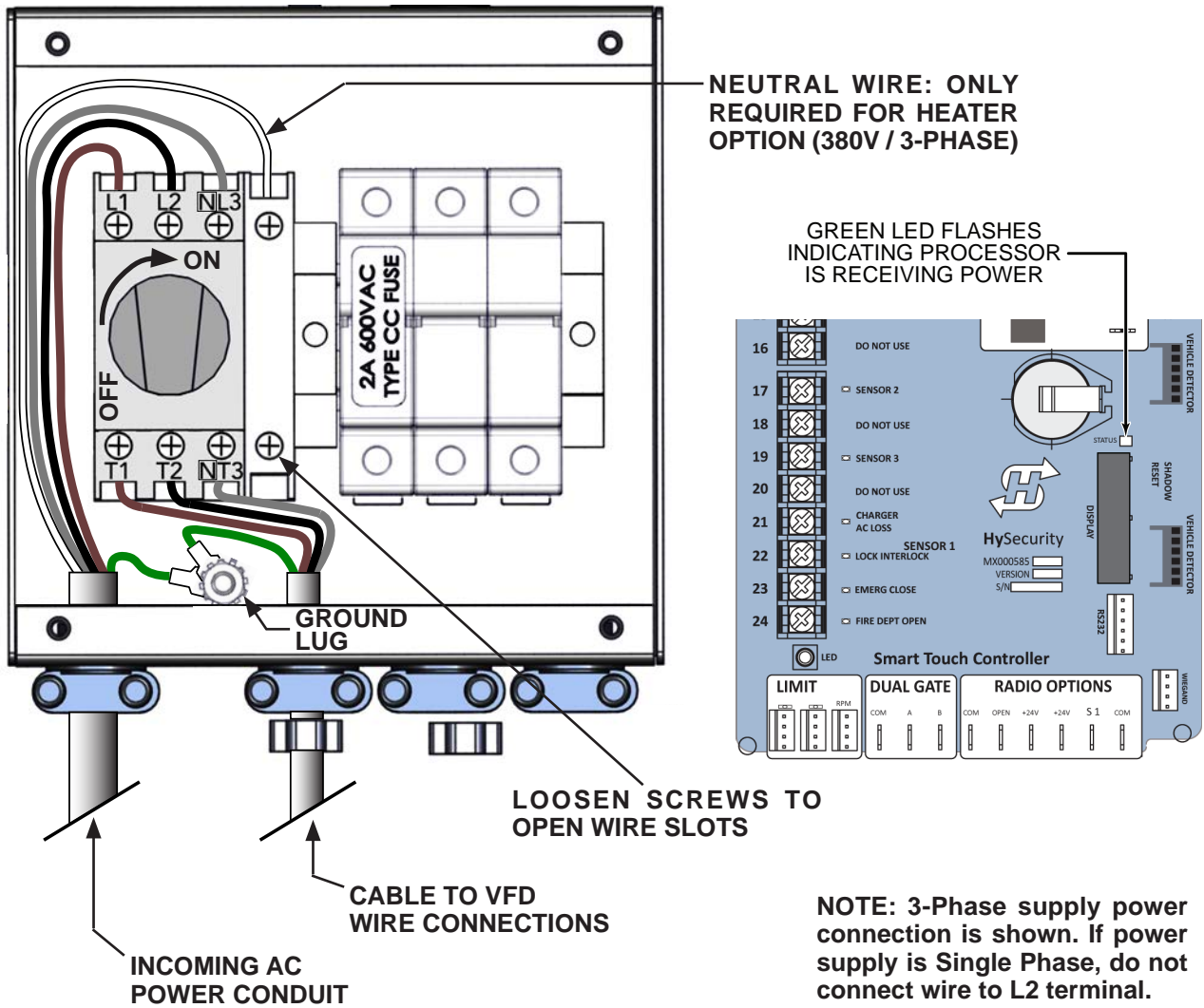

Figure 3. Wiring AC Power

SITE CONSIDERATIONS

HySecurity gate operators are intended for permanent installation. Prepare the site with the following considerations:

- Make sure all electrical wiring is properly routed via conduits entering the pivot or catch posts.
- Check the distance of the wiring run from the main panel to the gate operator. Make sure the wire size of the branch circuit supplying power to the gate operator is large enough to avoid excess voltage drop. Refer to "Appendix B" on page 96.
- Make sure the available power source matches the electrical requirements specified on the voltage nameplate.

CAUTION

Each gate operator is built to run on a specific line power voltage and phase. Failure to ensure the source voltage, phase and frequency match that is specified for the equipment may result in severe damage to the equipment.

- Make sure a 20-amp circuit (minimum) protected with a 20-amp Inverse Time Breaker is provided.
- Verify that the operator is electrically grounded per NFPA 780 and NEC Article 250, and local codes.
- Both pivot and catch posts must be plumb and level, and on grade with the roadway surface. Slope drainage ¼-inch per foot within 2 feet of the operator (2 cm per meter).

WIRE SIZING AND RUNS

Supplying a gate operator with the correct electrical service is crucial to the performance of the operator and the life of its electrical components. If the wire size used is too small, the voltage loss, especially during motor startup, will prevent the motor from attaining its rated horsepower. The percentage of horsepower lost is far greater than the percentage of voltage loss.

A voltage loss can also cause the control components to chatter while the motor is starting, substantially reducing their life due to the resultant arcing. There is no way to restore lost performance resulting from undersized wires, except to replace them. Be sure to choose a sufficient wire size at initial installation to avoid costly rewiring.

ARM POSITION SENSOR — SETTING LIMITS

SETTING THE CLOSE & OPEN LIMITS

NOTICE

Before turning the power disconnect switch to ON, make sure all site requirements concerning proper wiring, safety, foundation installation, and electrical power have been met.

When set, position sensing remains intact even if power is lost. The only exceptions occur when factory defaults are reinstated, or the Smart Touch Controller is replaced.

After establishing the the close and open limits by following the steps on the next page, cycle the barrier arm a few times. You can fine-tune the close limit, if need be. For example, if the barrier arm bounces slightly when it drops into the catch post, the Close Limit Adjustment setting, located in the User Menu, is available for making slight adjustments (within 1%) of the established limit position. See "ADJUSTING the CLOSE LIMIT — USER Menu" in this section.

Display	Selections
LEARN CLOSE INCHES: XX.X	<p>Learn Close Limits. See Figure 5.</p> <p>Choose one of the following bulleted procedures depending on the arm location.</p> <ul style="list-style-type: none"> ■ The arm is in the desired horizontal closed position – press Stop twice. The buzzer chirps twice and the full close stop is retained in memory. ■ The arm is not in the desired closed position - press and hold the Close button until the arm drops to full close. (Flashing numbers decrease while the arm is closing.) Do NOT crush the bumper or create a sag in the barrier arm. If either scenario occurs, press and hold Open to reverse direction for a second or two. Release the button. To retain the closed position press Stop twice. The buzzer chirps twice and the full close stop setting is retained in memory.
LEARN OPEN INCHES: XX.X	<p>Learn Open Limits. See Figure 6.</p> <p>Press and hold the Open button until the barrier arm reaches the open position you desire. Note that the vertical limit occurs at 94.5, not 100. Release the Open button. Do NOT crush the bumper. If the arm passes the vertical limit, you can press and hold Close to reverse direction.</p> <p>Press Stop twice to preserve the open stop location in memory. The buzzer chirps twice and the full open stop is retained in memory.</p>

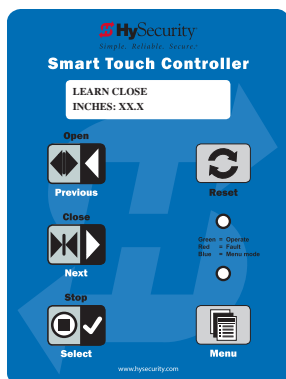

Figure 5. Learn Close

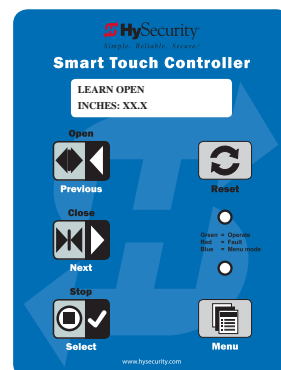

Figure 6. Learn Open

ARM POSITION SENSOR — SETTING LIMITS

ADJUSTING THE CLOSE LIMIT — USER MENU

The Close limit is established during the initial setup. To fine-tune the full close position, use the CA setting in the User Menu and follow the steps below.

NOTICE

The arm position can only increase or decrease within 1% of its original learned limit setting. If you need to change the barrier arm position to a greater degree, refer to setting the "Setting the Close & Open Limits".

1. To enter the User Menu, press Menu twice.
2. Press Next to scroll through the available menu selections.
3. When CA 0 appears, press Select. The two letters blink.
4. While blinking, press Next so CA 1 appears. Based on the function you want to perform, press one of the following menu buttons.

Menu BUTTON	Function
Next	Sets the close limit slightly above its existing closed position. As you go up the scale (1 to 5). Display your preference and then press Select. The close position is progressively higher.
Previous	Sets the closed limit slightly below its existing closed position. Continue through the -1 to -5 settings. As you go down the scale, the barrier arm's closed limit setting changes slightly, moving further into the catch post's bumper. Display your preference and then press Select.

RESETTING LIMIT MENU

To exit the close adjustment setting, press Menu.

1. Cycle the barrier arm open and close several times to see if the close limit is adjusted correctly.
2. If further adjustment is needed, take steps 1 - 4 until the close limit is set at the desired location. If a larger adjustment is required, follow the instructions in, "Resetting Open and Close Limits" on page 21.

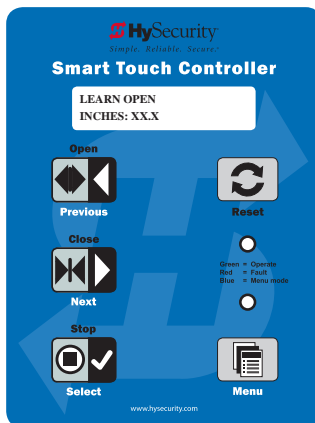

Figure 7. Learn Open

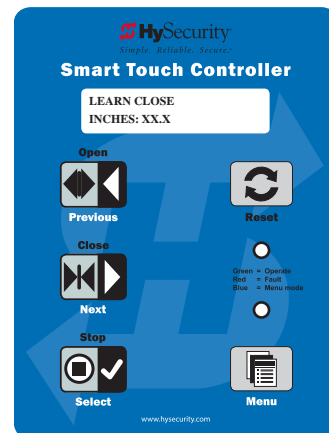

Figure 8. Learn Close

ARM POSITION SENSOR — SETTING LIMITS

RESETTING OPEN AND CLOSE LIMITS

Resetting the open and close limits is easily accomplished by accessing the Installer Menu.

Access to the Installer Menu is through the User Menu. See the flowchart (Figure 9) below. See Figure 10.

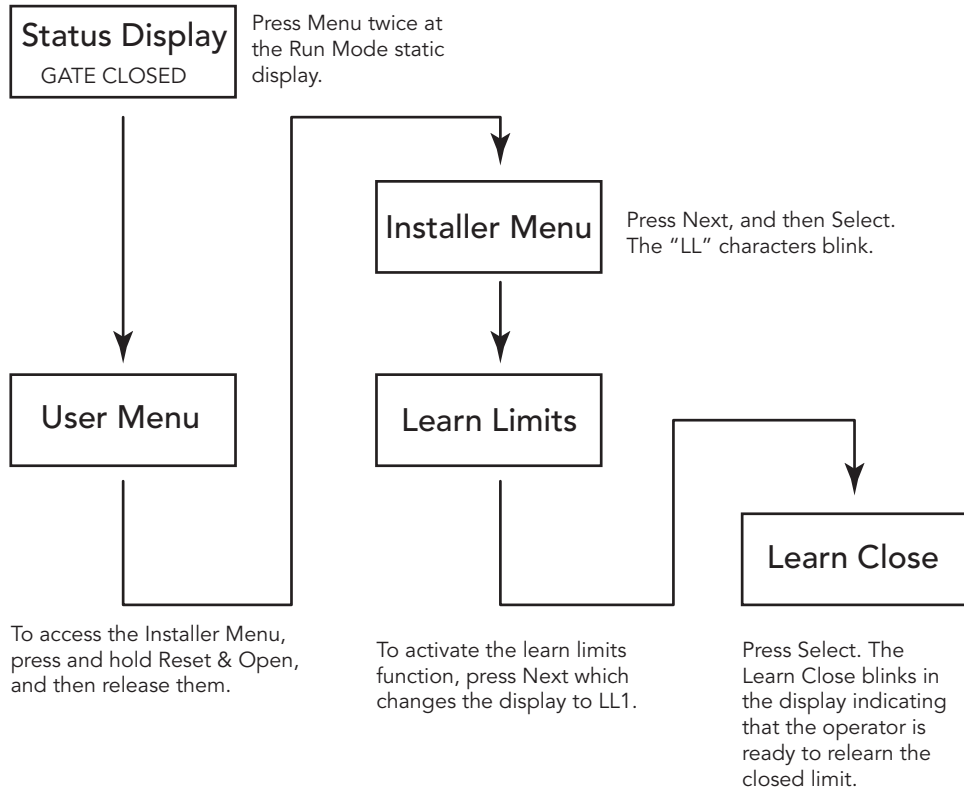

Figure 9. Learn Limits Menu Layout

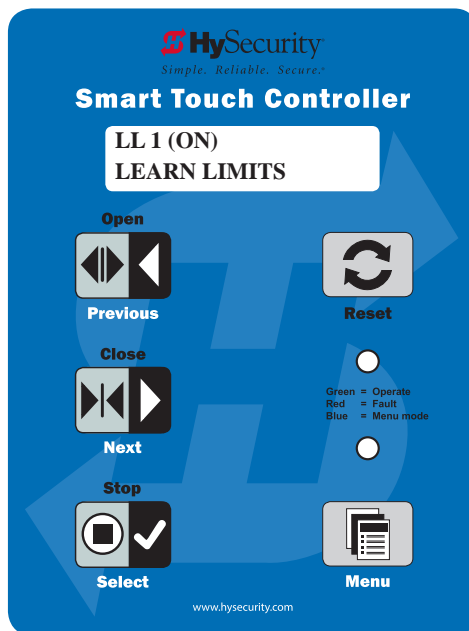

Figure 10. S.T.A.R.T. Learn Limits

ARM POSITION SENSOR — SETTING LIMITS

SETTING THE CLOSE TIMER

As an added security measure and to make sure the Security gate closes automatically within a reasonable time frame after all loops are cleared, the Close Timer may be set to the appropriate number of seconds.

The Close Timer assigns how many seconds will pass before the gate operator initiates closure of a fully opened gate after all open commands and reversing sensor inputs have ceased and loops cleared.

To adjust the time (1 to 99 seconds) it takes before the operator initiates gate closure, take the following steps:

1. At a gate status display, press the Menu button twice. This accesses the User Menu and the Close Timer display appears.

NOTICE

If you want gate personnel to operate the gate with the Hold to Close feature found in some push button stations, then set the Hold to Close menu item to 1. When the Hold to Close menu item is active (set to 1), the Close Timer menu item is unavailable.

2. Use the Select, and then Next or Previous buttons to navigate and change the number of seconds appearing on the display. Refer to "Menu Mode Navigation" on page 25.
3. To exit the User Menu, press the Menu button. The gate status appears in the display indicating you have returned to Run Mode.

TEST THE OPERATOR

Complete the installation by testing the operation of the M30/M50 barrier arm.

NOTICE

The operator must be turned on and in Run mode. A Run mode display appears on the STC. If a Run mode status does not appear on the display, press Reset. If an error, alert, or fault appears on the display, refer to the "Troubleshooting" section to learn how to clear the display and return to Run mode.

1. Press Open to raise the M30/M50 barrier arm.
2. Test the operator.
 - Cycle the M30/M50 barrier arm a few times by pressing the Close and Open buttons.
 - If installed for emergency fast operation, test the EMERGENCY CLOSE using the constant hold device. Observe the travel speed of the M30/M50 barrier arm when you press and hold the Emergency Close button. It will close a second or two faster than normal operation and ignore any photo eye, vehicle loop, or other safety device inputs.

NOTICE

If additional accessories are to be added, read about "STC Inputs & Wiring" on page 44.

CONTROL PANEL OVERVIEW

This section provides an overview of the the electrical controls found in your gate operator. The illustrations highlight the various components and describe their function. Each callout explains where to find more information about the component.

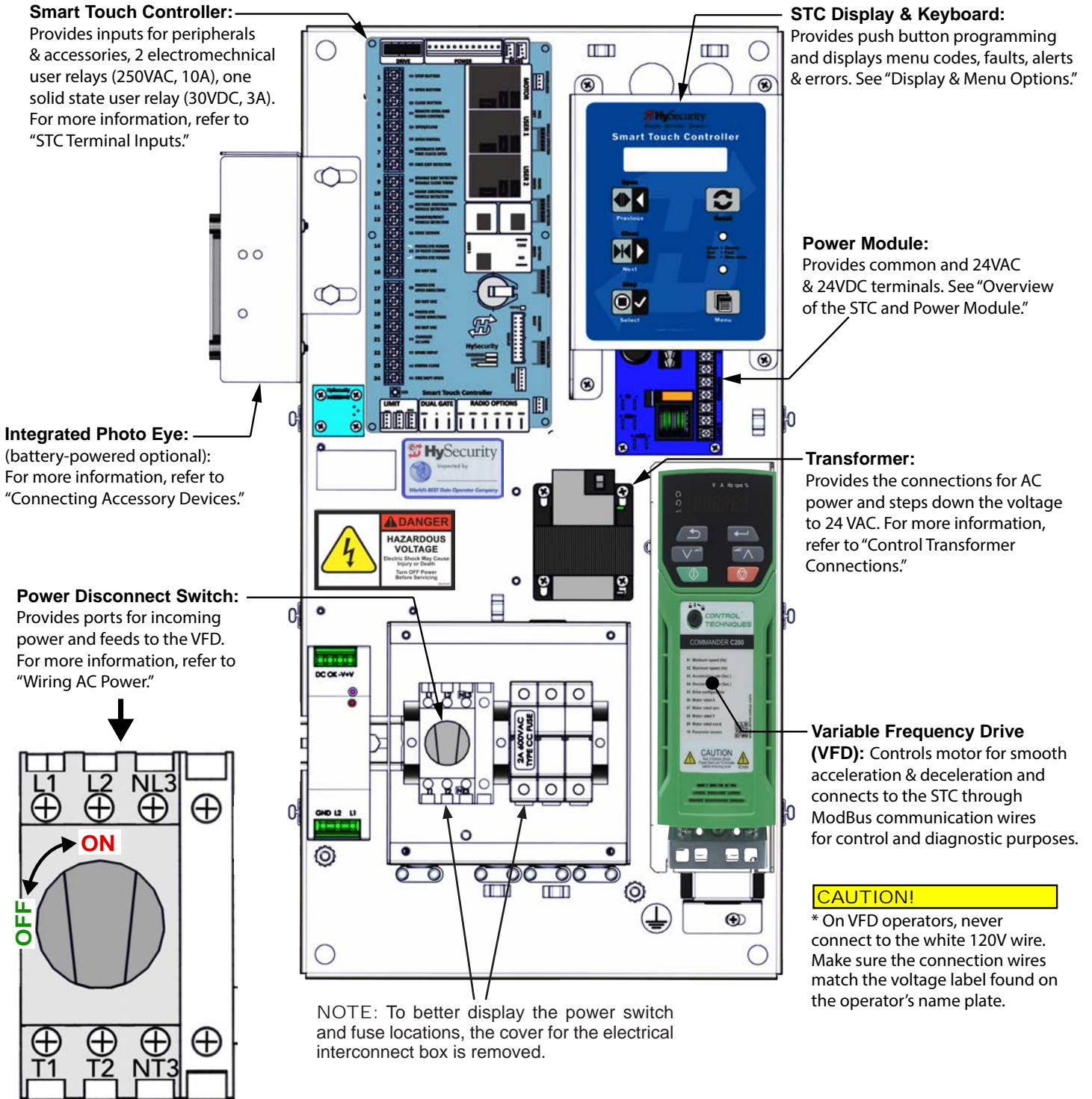

Power Disconnect Switch

- Left to turn **OFF**
- Right to turn **ON**

Figure 11. Contol Panel

Highly sophisticated software provides three different modes of operation: *run*, *menu (program)*, and *fault*. How to navigate using the Smart Touch Controller (STC) keypad, interpret status display codes and configure the operator is found in this section.

INITIAL SETUP

Once you have completed the installation, attached the wired accessories and turned the power ON, you're ready to configure the operator. Two different approaches exist: See Figure 12.

- Connect a laptop computer to the serial (RS-232) port, check for the most current software version and then set the operator menu configurations via the START software.

NOTICE

Use a laptop computer at your place of business to conveniently download the free S.T.A.R.T. software and most current software version from support.hysecurity.com before heading out into the field. This makes it easy to adjust settings using a laptop.

- Manually navigate through the User and Installer Menus using the STC keypad. The instructions for performing this second option are provided in this section.



Figure 12. S.T.A.R.T. Initial Setup

UNDERSTANDING THE DISPLAY AND KEYPAD

The STC display and keypad provide access to the operator's sophisticated software and functionality. See Figure 13.

Three different operational modes exist:

- Run Mode - gate is operational, awaiting commands.
- Menu Mode - motor disengages and operator commands are ignored. Data entry, menu navigation, and menu selection can be accomplished via the keypad or through a S.T.A.R.T. software connection using the RS-232 port.
- Fault Mode - alerts, faults, or errors appear on the display. Some errors or faults can be reset with the Reset button while more serious faults require additional troubleshooting. Faults indicate a need for diagnosis and resolution. Refer to "Troubleshooting" on page 72.

The keypad lets you navigate, change, or clear the information in the display menus. The singular use of these keys is dependent on the operator mode.

The buttons with text above and below have two functions. Use these buttons to enter operating commands or navigate through the User and Installer Menus.

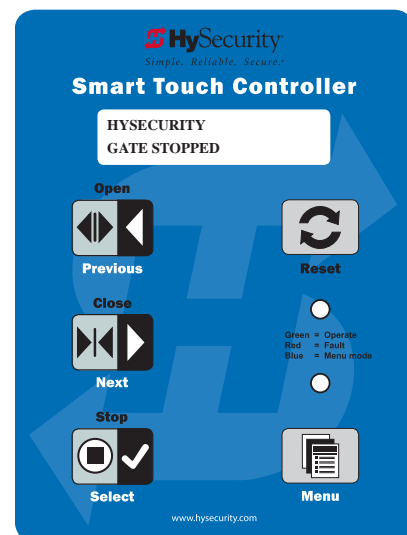

Figure 13. Display in Run Mode: Stop, Open, Close

MENU MODE AND THE STC KEYPAD

In Menu Mode, the motor disengages and operator commands are ignored. Data entry, menu navigation, and menu selection can be accomplished using the buttons on the Smart Touch Controller keypad. See Figure 14.

NOTICE

Menu Mode automatically returns to Run Mode if no activity (i.e. key presses) occurs for two minutes.

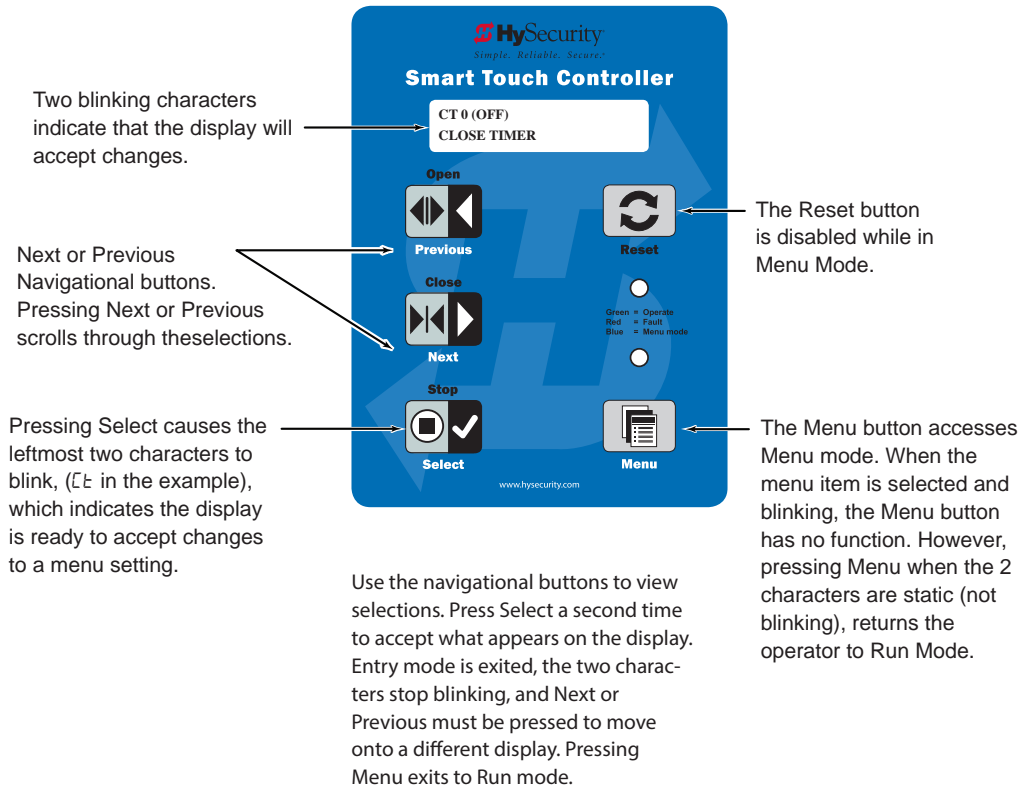

Figure 14. S.T.A.R.T. Initial Setup

MENU MODE NAVIGATION

Navigating within the menus is easy once you learn how the keypad buttons function. Refer to the following chart.

StrongArm M30/M50: Menu Mode Navigation Buttons			
To change that data appearing in the display	To navigate through the Selections	To choose what appears on the display	To navigate between menu items
Press Select. Two left characters blink.	Press Next or Previous. Continue pressing Next to view all selections.	Press Select. Blinking characters become static.	Press Next or Previous. Advance - press Next Previous - press Previous

RUN MODE AND THE STC KEYPAD

The Run Mode displays appear static when the operator is ready and waiting for a run command. When the display is flashing "GATE OPENING" or "GATE CLOSING", a command has been received and the barrier arm is in motion. The command may come from a variety of sources: a card reader, push-button remote, or recognition of a vehicle passing over a loop detector. In all cases, the operator "runs" the motor when it receives an operational command.

Three displays indicate the position or status of the barrier arm. The keypad entry used to access the User or Installer menus, begins at one of these Run Mode displays. See Figure 15.

NOTICE

Menu Mode automatically returns to Run Mode if no activity (i.e. key presses) occurs for two minutes.

Pressing Reset clears alerts or faults and returns to Run Mode.

NOTE: Press Reset at any Run mode status display to view the software version. For example: h4.35

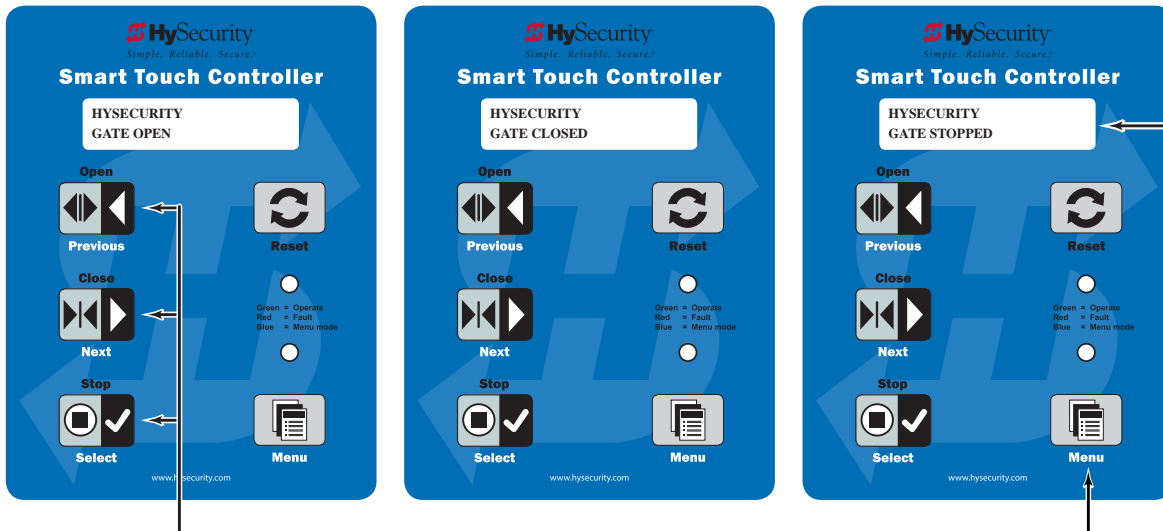

Pressing Open, Close, or Stop causes the gate to perform the command.

Pressing Menu scrolls through operator status displays and accesses the User Menu.

NOTE: Pressing the Menu button twice, bypasses the operator status displays.

Figure 15. Run Mode Displays

VIEWING OPERATOR STATUS DISPLAYS

Press the Menu button once and the operator status displays scroll past in two second intervals. Pertinent information appears to provide a quick overview of the operator's status or configurations.

The type of information that may scroll across the display includes: interlocked or sequenced gate (if applicable), operator type (OT), gate handing (RH or LH), clear opening (CO), Usage Class (UC), buss voltage, and cycle counter. See Figure 16.

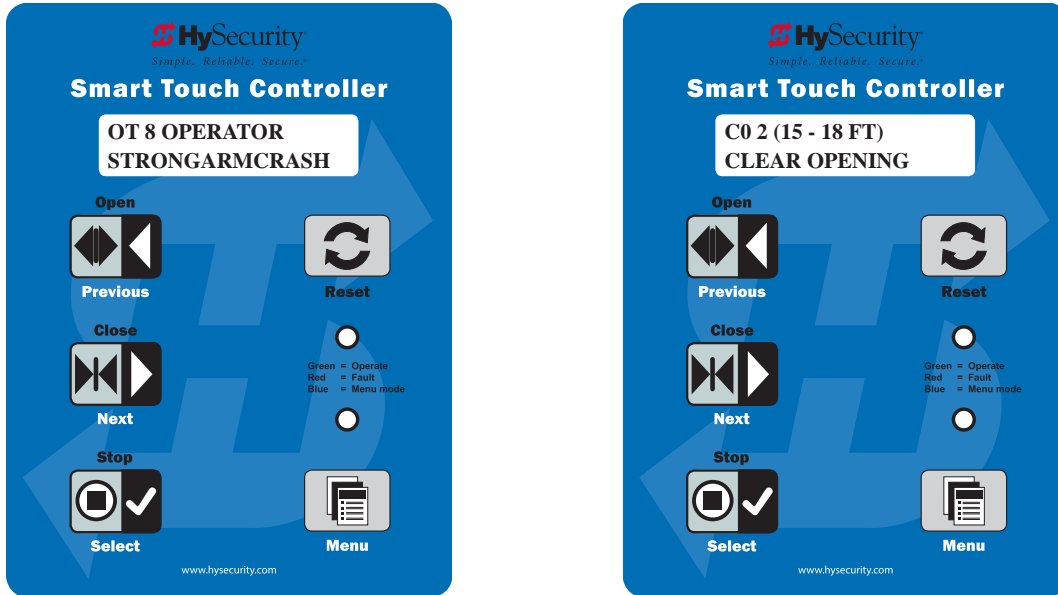

Figure 16. Example of Operator Status Display

The User Menu consists of several items which can be modified using the Smart Touch Controller keypad.

Access:

Pressing the Menu button, at one of the static Run Mode displays, causes the operator status displays to scroll past, stop and display the first user menu item. In most circumstances, CT (Close Timer) appears on the display. (Depending on the gate operator configuration, HC, HOLD TO CLOSE).

NOTICE
To access the User Menu, the operator must be in Run Mode. To bypass the operator status displays, press the Menu button a second time. (The 7-segment display is limiting compared to the OLED 16 character display. If you are working with a gate operator using the 7-segment display, refer to "Checklist - Post Installation" for a code list.)

Use the navigational buttons, Select, Next, and Previous to change or view the menu functions. Refer to the chart, "Menu Mode Navigation" on page 25.

Table 1 describes the User Menu items and supplies the factory defaults. (Factory default settings shown in bold.)

Table 1. User Menu			
User Menu	Setting Options	Menu Tasks & Explanations	STC Wire Connections
CT 0 CLOSE TIMER	0 = Timer disabled (OFF) 1 second to 99 seconds	NOTE: When the Hold to Close is set to 1, the Close Timer display does not appear and HC 1 becomes the User Menu entry display. If the Close Timer display appears, there is no need to change the default setting. The only exception occurs if your site is strictly using one Reset loop with no Obstruction loops, which is NOT the recommended site design for fortified sites. The Close Timer assigns how many seconds before the open arm initiates closure. Keep the setting at 0 if a hard-wired, push-button control device is being used. Refer to HC.	Not applicable (N/A)

Table 1. User Menu

User Menu	Setting Options	Menu Tasks & Explanations	STC Wire Connections
HC 0 HOLD TO CLOSE	0 = off 1 = on	Set to 0 to produce an Arm closure when a momentary signal is transmitted. Set to 1 if a constant hold to close signal, such as a push button control, is being used. A setting of 1 also deactivates the automatic close timer and causes its menu to disappear. The Hold to Close replaces the Close Timer display as the User Menu entry display.	COM Close
HO 0 HOLD TO OPEN	0 = off 1 = on	Similar to Hold to Close, but configures the Open inputs for a constant-hold function. 0 = Momentary open signal 1 = Constant hold open push button required You must set HO to 1 to comply with UL 325 Type D protection.	COM Open
RO 0 (OFF) RADIO OPEN/ CLOSE	0 = off 1 = on	A setting of zero, configures radio input for open only. Setting 1 adds the capability for radio input to close the arm, but only when it is fully open.	COM RADIO Open

Table 1. User Menu

User Menu	Setting Options	Menu Tasks & Explanations	STC Wire Connections
BF 1 (ON)	0 = (OFF) 1 = (ON) 2 = (ON 2 SEC) 3 = ON THRU OUT	Controls the warn-before-operate buzzer and can be configured three ways: Set to 0: Buzzer is disabled. The buzzer will still beep if alerts, faults, errors, or entrapment occur. Set to 1: Buzzer beeps for 3 seconds before arm moves and continues through entire length of travel. Set to 2: Buzzer beeps for 3s before arm moves and continues for 2s of travel. Set to 3: Available on barrier operators only. Buzzer beeps when gate starts to move and continues throughout gate travel.	Not applicable (N/A)
FA 0 (OFF) FORCE OPEN ALERT	0 = off 1 = on	Intended for highly secure facilities. Set to 1, the operator sounds the 3-second "warn before operate" buzzer alarm and initiates a closure if the arm is forced open and the closed limit switch disengages. The motor starts to secure the arm. If the arm does not fully close within 4s, the motor turns off and the buzzer sounds for 30 seconds. The display shows ALERT 1.	N/A
DA 0 (OFF) DRIFT CLOS ALERT	0 = off (standard) 1 = on (detailed)	Set to 1, the operator sounds the 3-second "warn before operate" buzzer alarm and initiates an open command if the arm is forced, or drifts, off the open limit switch. The motor starts to reopen the arm. The motor runs for a maximum of 4s and, if the arm is not fully open at the end of this period, the buzzer sounds for 10s. ALERT 2 appears on the display.	N/A

Table 1. User Menu

User Menu	Setting Options	Menu Tasks & Explanations	STC Wire Connections
PE 0 (OFF) PHOTO EYE ALIGN	0 = off 1 = on	Set to 1, the operator serves as an aide in photo eye transmitter/receiver alignment. The buzzer chirps once when the emitter and receiver are not aligned. When the emitter and receiver are aligned, the buzzer chirps twice. If they go out of alignment again, the buzzer will chirp once. The Alignment Mode is reset with a close-limit input or by pressing the Reset button. NOTE: If the operator doesn't run when the power switch is initially turned ON, check the alignment of the photo eye and all the photo eye connections.	EYE Open EYE Close EYE COM
CL 0 (OFF) SET CLOCK	0 = Display 1 = Set Clock	To adjust the hour, minute, day, or month to a different time zone, select 1. Once the clock is set, the display returns to the 0 setting.	N/A
Ld 5 LCD Contrast	5 0 through 9	Adjusts the contrast of the display. Available settings from low contrast 0 to 9 high contrast, with a factory default setting of 5. NOTE: Not used or available with the OLED 32-character display.	N/A
CA (OFF) CLOSE LIMIT ADJ	0 = preprogrammed limit 1 = adjustment mode -5, -4, -3, -2, -1, _ 1, 2, 3, 4, 5 (Each number represents a change in pitch of about 1/10% from the memorized close limit setting.)	Allows fine-tune adjustments within 1% of the memorized closed limit position. To adjust the arm further into the closed position, assign a negative number. If fine-tuning does not provide satisfactory results, you may want to reset the position of the limits. See Learn Limit Reset in the "Installer Menu" on page 42.	N/A

Table 1. User Menu

User Menu	Setting Options	Menu Tasks & Explanations	STC Wire Connections
AL 1 (FLASHING) CLOSED ARM LIGHTS	0 = No flashing when closed 1 = flashing when closed	<p>This menu option controls the LED blinking behavior when the black power wire for the LED lights is connected to the white STC connector snap plug.</p> <p>NOTE: For non-blinking LEDs, connect to the black STC connector snap plug.</p> <p>Settings are either 0 (zero) or 1 (one) as follows:</p> <ul style="list-style-type: none"> • When set to 1, the arm's LEDs blink constantly while closing or opening and remain blinking when closed. • When set to 0, the row of LEDs blinks while closing or opening, but then lights continuously (without blinking) when the arm is in the closed position. 	Black LED power cord to white STC connector snap plug.
DS 0 (OFF) DIAGNOSTIC LOGS	0 = off (standard) 1 = detailed	Set to 0, the STC logs pertinent operator events such as faults, errors, or menu manipulation. When experiencing intermittent problems, set this item to 1 to record all operator open and close events, in addition to the normal alert, fault and error logs. This parameter automatically resets to the default 0 (off) after 24 hours.	An RS-232 cable and laptop computer loaded with HySecurity free S.T.A.R.T. software is required to read the log file. Visit support.hysecurity.com
PD 0 SET PASSWORD	0 = Off 1 = On (Set Password)	NOTE: A System Address (SA) value in the installer Menu must be set before the Set Password display appears in the User Menu. To enter a password (up to 80 characters) for network connectivity, select 1. You can use the menu navigation buttons to enter the password (SELECT, NEXT, SELECT). When the password is set, the display returns to the 0 setting.	Network: Ethernet or RS-485

The Installer Menu items provide advanced configurations for the StrongArm operators. Access to the Installer Menu is through the User Menu. The navigational buttons are the same in both menus. Refer to "Menu Mode Navigation" on page 25.

Access:

While a static Run Mode code is being displayed, press the Menu button twice. (Bypasses the operator status displays. See Appendix D for 7-segment display codes.) See Figure 17.

When the Close Timer display appears (Hold to Close, if the Close Timer display is hidden):

1. Access the Installer Menu by simultaneously pressing and holding the Reset and Open buttons.
2. Release both buttons and the first item in the Installer Menu appears.

NOTICE

Installer Menu options can also be configured through the use of a laptop computer and the S.T.A.R.T. software.

Table 2 describes the Installer Menu items and supplies the factory defaults. (Factory settings shown in bold.)

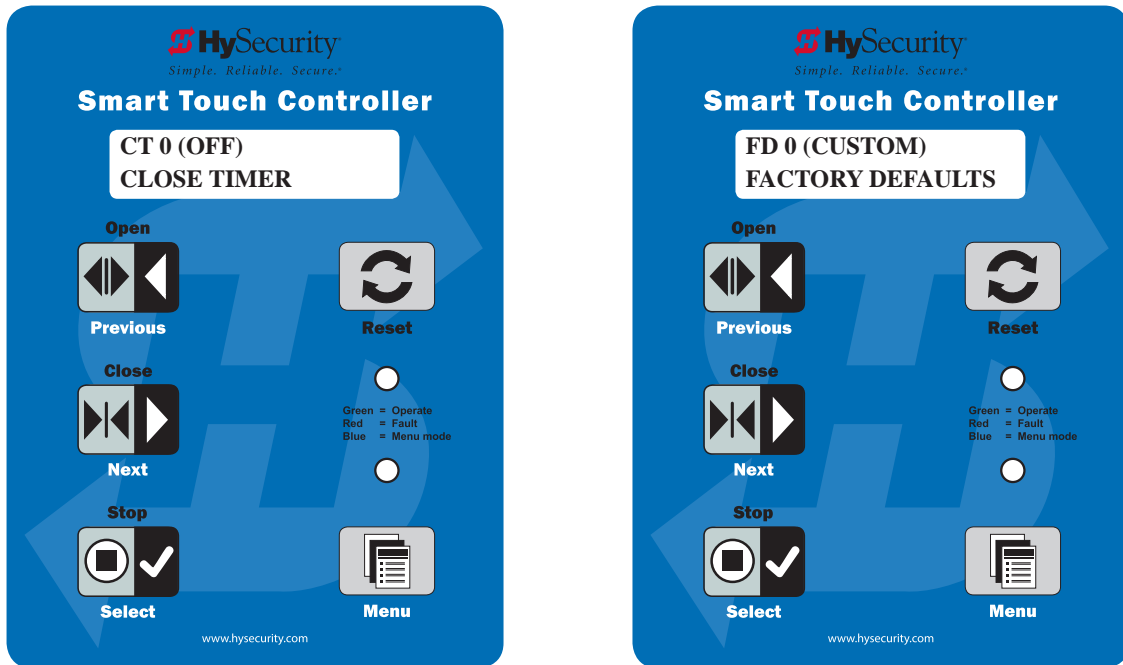

Figure 17. Installer Menu

Table 2. Installer Menu

Installer Menu	Setting Options	Menu Tasks & Explanations	STC Wire Connections
OT 0 OPERATOR	<p>0 = operator type 1 = SlideDriver (HSG) all models except 50 VF series 2 = SwingRiser (HRG) 3 = HydraLift (HVG) 4 = StrongArm (HTG) 7 = 50VF series SlideDriver 8 = StrongArm (M30/M50) 9 = HydraSwing 10 = HydraSupply XL</p>	<p>Select the appropriate number for the operator. NOTE: This menu item only appears if the Smart Touch Controller is being replaced. CAUTION: If you are replacing an STC board, remember to transfer the operator's menu settings from the existing board to the replacement board. Refer to the installation instructions that accompany the replacement STC board.</p>	<p>Not applicable (N/A)</p>
AD 0 (OFF) AC/DC GATE	<p>0 = gate disabled 1 = AC (alternating current) 2 = DC battery-power (OT 1-4, 10) 3 = HyInverter Power Supply</p>	<p>Select the type of power that the operator uses and is appropriately wired. NOTE: This menu item only appears when you set the OT (operator type).</p>	<p>N/A</p>
SP 0 SET SPEED MODBUS CONTROL	<p>0 = gate disabled 1 = No ModBus communication** 2 = 2 ft/s 3 = 3 ft/s **NOTE: A setting of 1 indicates no ModBus communication or wiring is present. The VFD uses its factory settings to control speed.</p>	<p>Set the maximum speed for the gate. NOTE: This menu item only appears if the SlideDriver operator is part of the 50VF series. It does not appear with any other operator type. CAUTION: A setting of 2 or 3 requires extended limit ramps to be installed on the drive rails!</p>	<p>N/A</p>

Table 2. Installer Menu

Installer Menu	Setting Options	Menu Tasks & Explanations	STC Wire Connections
UC 0 USAGE CLASS	0 = gate disabled 1 = single family dwelling 2 = multi-family 3 = industrial * 4 = guarded location* *not serving the general public	Set the UL usage class. The installer must set the usage class for the operator to function. NOTE: The usage class setting does not appear on products.	N/A
SH 0 GATE HANDING	0 = gate disabled Right = viewed from the secure side, the gate moves right to open Left = viewed from the secure side, the gate moves left to open	Handing only appears on slide gate operators (OT 1, 5 – 7). On slide gates, the installer must set the operator's handing before the operator will function.	N/A
C0 0 CLEAR OPENING	0 = gate disabled 1 = 12 to 14 ft (366 to 427 cm) 2 = 15 to 18 ft (457 to 548 cm) 3 = 19 to 24 ft (579 to 732 cm)	This menu item only appears if the operator type is a barrier arm. NOTE: The clear opening is 2 feet less than the actual barrier arm length. Standard clear openings in feet: 12, 14, 16, 18, 20, 22, 24.	N/A
BU 0 LOUDEST BUZZER	0 = buzzer not set 1 = Frequency 1 * 2 = Frequency 2 * *Select the loudest buzzer	This menu item only appears if the operator type selected is 1 through 4. Choose the loudest buzzer. The operator provides an audible beep when you select either buzzer 1 or 2. Make sure to choose the loudest audible buzzer sound for your operator type.	N/A
Installer Menu	Setting Options	Menu Tasks & Explanations	STC Wire Connections

Table 2. Installer Menu

FD 0 (OFF) FACTORY DEFAULTS	0 = user settings 1 = reload factory settings	Select setting 1 to return the operator to factory defaults. Globally restores all menu settings back to new operator status. NOTICE: If factory defaults are restored, any customized menu settings will need to be reprogrammed. You can save your customized menu settings using a PC laptop & S.T.A.R.T.	N/A
DG 0 (OFF) DUAL GATE	0 = solo operator 1 = Secondary unit 2 = Primary unit 3 = Sally Port A 4 = Sally Port B	Establishes communication after wiring dual gate connections between two operators in Primary/Secondary or Sally Port site configurations. This menu item appears if the sequenced gate menu item SG is set at 0 (off).	Dual Gate COM (Gate 1) to Dual Gate COM (Gate 2) A to A B to B
SG 0 (OFF) SEQUENCED GATE	0 = off 1 = Loop Layout/Site #1 2 = Loop Layout/Site #2 3 = Loop Layout/Site #3 4 = Loop Layout/Site #4	Establishes communication after wiring two or more operators as sequential gates. This menu item only appears if the Dual Gate menu item DG is set at 0 (solo operator). NOTE: Access the User Menu in both operators and set a Close Timer if desired.	Connect Dual Gate COM (Traffic Gate) to Dual Gate COM (Security Gate) A to A B to B
Installer Menu	Setting Options	Menu Tasks & Explanations	STC Wire Connections

Table 2. Installer Menu

CH 0 (AC) CHARGER TYPE	0 = AC powered charger 1 = Solar powered charger	Does not appear on an AC-powered operator. The menu item only appears when using the DC Charger unit.	
FO 0 (DISABLED) FIRE DEPT OPEN	0 = disabled 1 = enabled	Enables the Fire Dept. Open input. When set to 1, the open signal received by the operator overrides all photoelectric eyes and edge sensors, and opens the Arm. Pressing the Reset, Open, or Stop button is required before the Arm can be closed.	+24V Fire Dept Open (#24)
OC 0 (DISABLED) EMERGENCY CLOSE	0 = disabled 1 = enabled	Enables the Emergency Close input. When set to 1, the constant hold close overrides vehicle detectors, photo eyes and edge sensors, and closes the Arm. Pressing the Reset button once or the Open button twice is required before the Arm will open.	+24V EMERG CLOSE (#23)
EC 0 STOP ONLY EYE CLOSE LOGIC	0 = Close eye stops only 1 = Reverse to full open with barrier arms (2 second reverse to open on swing, slide, or vertical gates) 2 = Reverse to full open on swing slide, or vertical gates.	The default setting is non-reversal if the close photo eye is triggered. A setting of 1 causes the Arm to reverse and travel full open if triggered while closing.	EYE Close #19 EYE COM (Inputs #14 or #15)
Installer Menu	Setting Options	Menu Tasks & Explanations	STC Wire Connections

Table 2. Installer Menu

<p>PC 1 N.C. INPUT PHOTO EYE OUTPUT</p>	<p>0 = Normal Open PE output 1 = Normal Closed (supervised)</p>	<p>The default setting is for photo eyes with N.C. Normally Closed outputs for Operators sensor only. When set for NC, the connection is monitored and any short circuit fault will generate a FAULT 2 alert which requires a Stop or Reset button press to clear and enter.</p>	<p>Sensor 3 Sensor COM 4 wires total: COM/+24 COM/ PHOTO EYE CLOSE (#19)</p>
<p>GC 0 N.O. INPUT GATE EDGE OUTPUT</p>	<p>0 = Normally Open Edge 1 = Normally Closed (supervised)</p>	<p>The default setting is edge sensor with Normally Open (NO) output. The optional setting of 1 requires an (NC) output.</p>	<p>Sensor 1 or 2 (#13) COM</p>
<p>TC 1 (TIME CLK) TIME CLK/ INTLOCK</p>	<p>0 = Select Time Clock 1 = Select Open Interlock</p>	<p>Configures the input at Terminal No. 7 on the STC to be either for the Arm interlock function, or for an external time clock to open input. The default setting is TC 1 for the interlock function.</p>	<p>INTERLOCK OPEN (#7) COM</p>
<p>DT 0 STANDARD DISABLE FUNCTION</p>	<p>0 = Disable Free Exit 1 = Disable Close Timer</p>	<p>Configures Terminal #9 input to disable either the Free Exit function or, alternately, the Timer Close function. The default setting disables the Free Exit function.</p>	<p>DISABLE EXIT DETECTOR (#9) COM</p>
<p>Installer Menu</p>	<p>Setting Options</p>	<p>Menu Tasks & Explanations</p>	<p>STC Wire Connections</p>

Table 2. Installer Menu

OR 1 REVERSE OUTSIDE OBS LOOP	0 = Pause closing only 1 = Enable reversing to open 2 = Ignore and continue closing	The default (1) is for full reversal when the Outside Obstruction Loop is triggered. A setting of 0 causes the Arm to pause when triggered while closing. The Arm closure continues as soon as the loop is clear again. A setting of 2 is provided for the most secure facilities where it is essential that the loop trigger is completely ignored and the Arm continues closing without pause or reversal.	OUTSIDE OBS LOOP (#11) COM or connection to Hy5B detector
IR 1 REVERSE INSIDE OBS LOOP	0 = Pause closing only 1 = Enable reversing to open 2 = Ignore and continue closing	The default is for full reversal when the Inside Obstruction Loop is triggered. A setting of 0 causes the Arm to pause when triggered. While closing, Closure continues as soon as the loop is clear again. A setting of 2 is provided for the most secure facilities where it is essential that the loop trigger is completely ignored and the Arm continues closing without pause or reversal.	INSIDE OBS LOOP (#10) COM or connection to Hy5B detector
Installer Menu	Setting Options	Menu Tasks & Explanations	STC Wire Connections

Table 2. Installer Menu

DL 1 STANDARD DETECTOR LOGIC	1 = Standard 2 = Quick Close 3 = Immediate Close 4 = Full anti-tailgate	Determines how the operator responds to a tail gate notification. NOTE: Does not appear in barrier arm operators.	
CR 0 REVERSE RLD PAUSE OPEN	0 = Reopen if reset loop triggered 1 = Pause only	The default setting reopens the arm Reset Loop detector is triggered while closing. A setting of 1 causes the Arm to only pause if triggered. While closing, Closure continues as soon as the loop is clear again.	Shadow/Reset (#12) COM or connection to Hy5B detector
CB 0 (OFF) RLD DISABLES ELD	0 = Normal operation of Free Exit 1 = Disable Free Exit	Setting 1 allows an RLD input to disable the Free Exit Detector (ELD) until the Arm is fully closed. Used in bi-directional traffic situations.	Shadow/Reset (#12) COM or connection to Hy5B detector
CP 0 (OFF) RLD COUNTS PBO	0 = Immediate closure 1 = Provides addt'l open time	The default allows the Reset Loop Detector when triggered and released, to close the arm immediately. The optional setting of 1 designates that the Smart Touch Controller remember 2 additional open commands if the open input is activated a second time while the Arm remains open. (For example, to prevent a vehicle from being stranded).	Shadow/Reset (#12) COM or connection to Hy5B detector
Installer Menu	Setting Options	Menu Tasks & Explanations	STC Wire Connections

Table 2. Installer Menu

EB 0 (OFF) ELD BACKOFF	<p>0 = Normal operation of Free Exit 1 = Back off close function</p>	The default allows normal latch open operation of the Free Exit detector. The optional setting of 1, creates an automatic close function if a vehicle triggers and then backs off the Free Exit Loop detector.	Free Exit Detector (#8) COM or connection to Hy5B detector
RL 0 DISABLED RELAY 1 LOGIC	<p>0 = Disabled 1 to 32 available</p>	Configures the function of the User 1 output relay. It has the capacity to switch both AC and DC loads and can be used for high voltage and/ or high current loads. Connect devices directly to the top of the relay: COM and either NO and/or NC contacts. Multiple logic function options exist. See "Table 5. Programmable User Relays" on page 52.	User 1 Relay
R2 6 CLOSE LIMIT RELAY 2 LOGIC	<p>0 = Disabled 1 to 32 available</p>	Configures the function of the User 2 output relay. It has the capacity to switch both AC and DC loads and can be used for high voltage and/ or high current loads. Connect devices directly to the top of the relay. Multiple optional logic function options exist. See "Table 5. Programmable User Relays" on page 52.	User 2 Relay
<p style="text-align: center;">Installer Menu</p>	<p style="text-align: center;">Setting Options</p>	<p style="text-align: center;">Menu Tasks & Explanations</p>	<p style="text-align: center;">STC Wire Connections</p>

Table 2. Installer Menu

R3 1 DISABLED RELAY 3 LOGIC	0 = Disabled	In the StrongArm M30/M50, Relay 3 is connected to the arm LED lighting and does not appear as an option in the Installer Menu. In other gate operators, Relay 3 configures the function of the User 3 output relay, which is an electronic relay with the capacity for switching a DC load only.	User 3 Relay
TL 2 (45 SECS) OPEN TIME ALERT	2 = 45 second delay 0 = 0s delay 1 = 15s 3 = 75s 4 = 105s 5 = 135s	Adjusts the time delay before activation of the User Relay 8 function.	User Relay
LT 3 (75 SECS) LOITERING ALERT	3 = 75 second delay 0 = 0s delay 1 = 15s 2 = 45s 4 = 105s 5 = 135s	Adjusts the time delay before activation of the User Relay. 13 functions see "Table 5. Programmable User Relays" on page 52.	User Relay
LL 0 (OFF) LEARN LIMIT	0 = Normal setting 1 = Erases the learned limit positions	Set to option 1, the system resets to allow relearning limits. Refer to "Resetting Open and Close Limits" on page 21.	N/A
Installer Menu	Setting Options	Menu Tasks & Explanations	STC Wire Connections

Table 2. Installer Menu

SA 0 (OFF) STC ADDRESS	0 = No network 1 to 99 = Network "drop" address	Sets the system address for network communication: 0 = no network communication 1-99 sets individual poling addresses.	RS-485. Involves additional hardware & software.
ELD 0 RUN MODE EXIT LOOP SET	0 = Run mode 1 = Show frequency 2 = Show call level 0-7 3 = Set Frequency	Controls the Hy5B Free Exit loop detector.	Hy5B
ILD 0 RUN MODE IN OBS LOOP SET	0 = Run mode 1 = Show frequency 2 = Show call level 0-7 3 = Set Frequency	Controls the Hy5B Inside Obstruction Loop detector.	Hy5B
OLD 0 RUN MODE OUT OBS LOOP SET	0 = Run mode 1 = Show frequency 2 = Show call level 0-7 3 = Set Frequency	Controls the Hy5B Outside Obstruction Loop detector.	Hy5B
RLD 0 RUN MODE RESET LOOP SET	0 = Run mode 1 = Show frequency 2 = Show call level 0-7 3 = Set Frequency	Controls the Hy5B Reset Loop detector.	Hy5B
S1 0 SENSOR #1 TYPE	0 disabled 1 (NOT USED) 2 (EYE CLOSE) 3 (EDGE CLOSE) 4 (EYE OPEN) 5 (EDGE OPEN) 6 (EDGE BOTH) 7 (EYE BOTH)	UL 325 - 2018 sensor input setting for external entrapment protection sensor monitoring. All three sensor types must be configured to a non-zero number before the gate operator will move the gate.	SENSOR 1 COM +24V SENSOR COM 10K resistor * *(Wired Edge sensor)
S2 0 SENSOR #2 TYPE	Same as Sensor 1	Same as Sensor 1	SENSOR 2 COM +24V SENSOR COM
S3 0 SENSOR #3 TYPE	Same as Sensor 1 Sensor 3 is hidden and defaults to Eye Close for StrongArm.	Same as Sensor 1 Sensor 3 is hidden and defaults to Eye Close for StrongArm.	SENSOR 3 COM +24V SENSOR COM

STC INPUTS & WIRING

This section provides information about the Smart Touch Controller, its inputs for peripheral connections, and its monitoring capabilities. This section explains how to:

- Make Connections on the Smart Touch Controller
- Integrate with Security Systems
- Connect Hy5B Vehicle Detectors
- Connect Accessory Devices
 - Entrapment Sensor Connections
 - Access Controls
 - Push-button station
 - User Relays

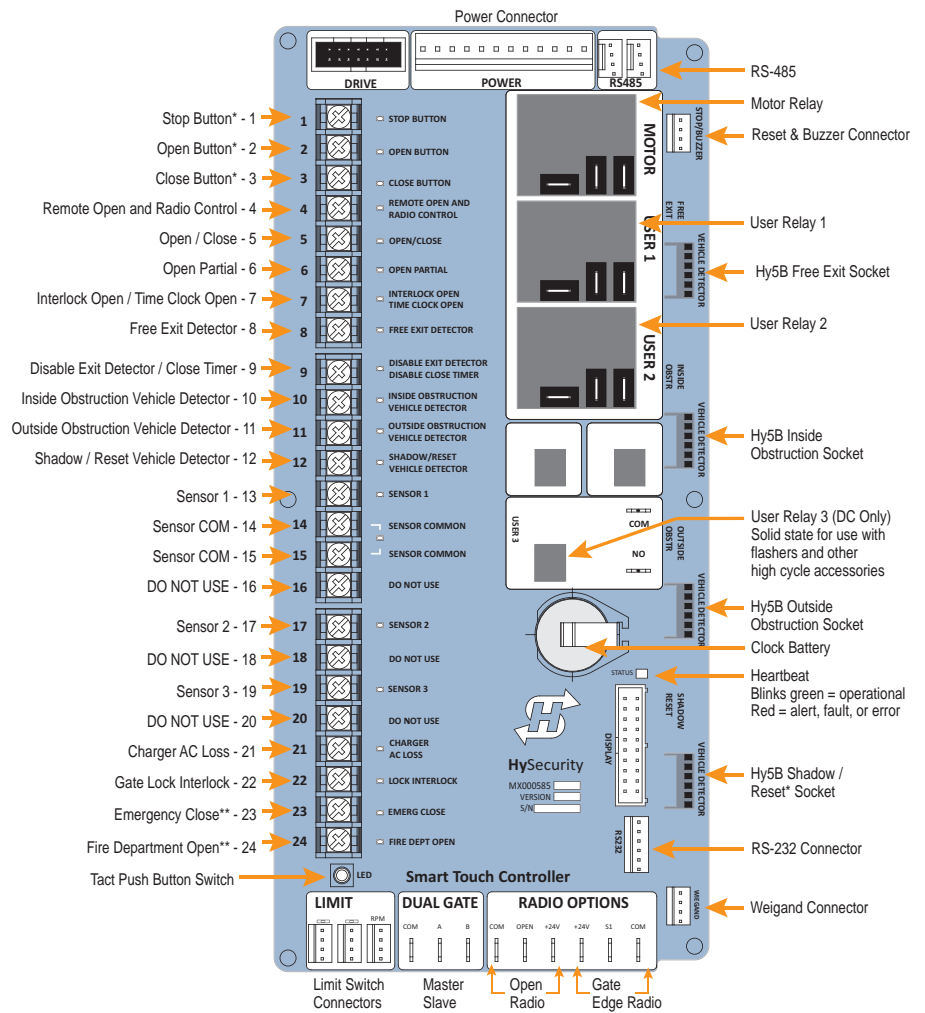
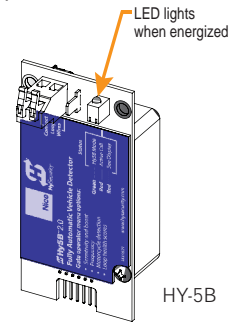

Figure 18. STC Inputs and Wiring

OVERVIEW OF THE STC AND POWER MODULE

The Smart Touch Controller uses LED's to indicate active inputs when AC power is present. To save power on operators that use only DC power, active inputs are shown only when you push the Tact push button. This Tact push button is at the bottom left corner beneath the #24 terminal input, as shown in Figure 19.

On a new operator, no active inputs should appear until external accessories and wiring are attached. If any inputs are active before connecting external wiring, refer to "Troubleshooting" on page 72.

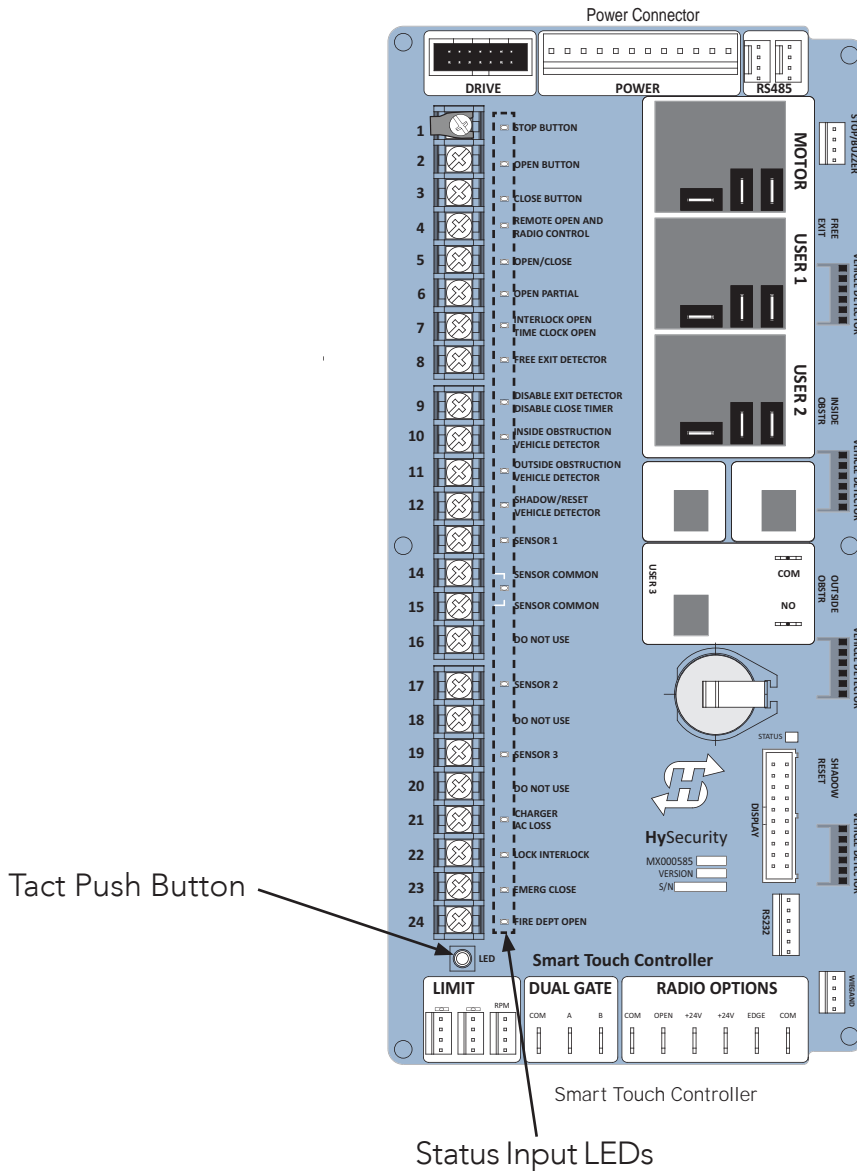

Figure 19. STC Overview

INTEGRATING WITH SECURITY SYSTEMS

The StrongArm M30/M50 provides a 2-wire, serial interface (RS-485 connection) which allows remote access to one or more operators. With software protocols provided by HySecurity, bi-directional status updates and control commands are easily integrated with a central controller (computer or server), which becomes the master to the connected operators. Up to 31 physical operators can be polled from the central master command station. Reset requests, gate control, gate status, and gate faults can be monitored and information can be retrieved from the central command station.

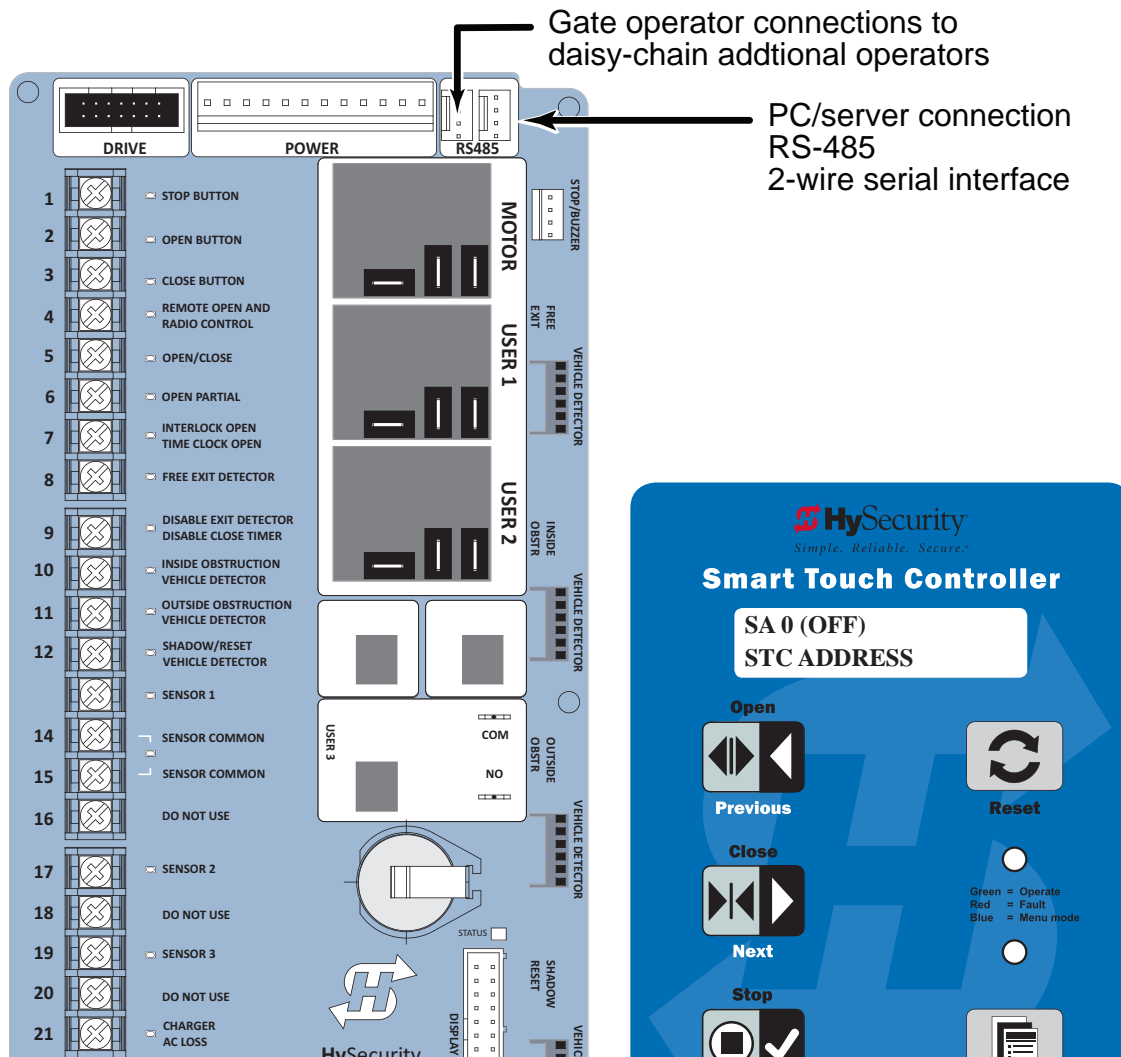

Figure 20. STC and SA Display in Installer Menu

Once the physical connection is made and protocols are established, an SA (System Address) must be assigned for each operator through its Installer Menu. For network communication, choosing a "SA" of 1 to 99 establishes individual network polling addresses. A "SA" of zero means no network communication is desired.

If you plan to connect operators to a networked central master command station, contact HySecurity for software protocols and additional information. Refer to "Contact Information" on page 3.

SMART TOUCH CONTROLLER INPUTS

When using AC power, an LED lights next to active inputs.

All the Smart Touch Controller inputs listed below are shown as a single input. The second wire is connected to the Common Terminal Bus on the Power Module.

1. Test the open and close function of the barrier arm before wiring to accessory devices (external control inputs). This makes it easier to troubleshoot if an unexpected functionality arises.

NOTICE

The Emergency Close and Fire Dept. Open inputs are an exception and require a +24V input. The +24V is located on Power Module next to the Common Bus. Refer to the drawing on page 51.

WARNING

Use Terminal Inputs 4, 5, 6, and 7 for external control devices. DO NOT connect an external control device to Input Terminals, 1, 2, or 3 unless the controls are located in clear view of the entire gate area and being constantly monitored and supervised.

Table 3. STC Inputs Chart

No.	STC Terminal	Wire Connections	Commonly used for...
1	Stop Button	Normally Closed input. Jumper to Common if input is not being used.	Line of sight, external stop button or 3-button station.
2	Open Button	Do not use for radio or remote access controls.	Line of sight, external open button or 3-button station.
3	Close Button	Do not use for radio or remote access controls.	Line of sight, external close button or 3-button station.
4	Remote Open & Radio Control	For radio/remote open device: Access the RO from the User Menu and set to 1.	Remote access control or radio controls
5	Open/Close Button	Connection for push button or radiocontrols.	Singular button device (multi-function)
6	Open Partial	Adjustable through the Installer Menu from 7 to 99 seconds. NOTE: Terminal is not used in StrongArm M30/M50.	Supervised access controls
7	Interlock Open/Time Clock Open LED	The default is Interlock Open (TC1) but can be configured as the Time Clock Open (TC 0) input. Refer to the "Table 2. Installer Menu".	Sequenced or interlocked gate inputs. Another use for this input is connection to a device that regulates the open timing.

Table 3. STC Inputs Chart

No.	STC Terminal	Wire Connections	Commonly used for...
8	Free Exit Detector	Refer to "Table 2. Installer Menu" EB	Vehicle detector, box type connections for free exit loop.
9	Disable Exit Detector/ Disable Close Timer	Free Exit is only disabled if the Close Limit Switch is tripped. If the Arm is partially opened, the Free Exit detector will trigger the Arm to open fully.	Connection to free exit loop. Installer menu enabled. See DT 0.
10	Inside Obstruction Vehicle Detector	See "Table 2. Installer Menu".	Vehicle detector, box type connections inside reversing loop
11	Outside Obstruction Vehicle Detector	See "Table 2. Installer Menu". CR 0	Vehicle detector, box type connections outside reversing loop
12	Shadow/Reset Vehicle Detector	See "Table 2. Installer Menu". CR, CB, and CP	Vehicle detector, box type connections. Shadow function for swing gates, reset function for barrier arm gates.
13	Sensor 1	See "Table 2. Installer Menu". GC	Configurable Object Detection Sensor
14	Sensor Common (-) 24 Volts Common	If photo eyes are used in place of vehicle detector loops, connect 24V Common to Power Supply COM & connect NO output to appropriate vehicle loop detector input: Terminals 8, 10, 11 or 12. See section on "Photo Eyes (Non-Contact) Installation" on page 62.	Photo eye open and close connections.
15	Sensor Common (-) 24 Volts Common		
16	DO NOT USE		
17	Sensor 2	See "Table 2. Installer Menu" EC & PC	Configurable Object Detection Sensor.
18	DO NOT USE		
19	Sensor 3	See "Table 2. Installer Menu". PC	Configurable Object Detection Sensor.
20	DO NOT USE		

Table 3. STC Inputs Chart			
21	Charger AC Loss	Jumper to Common.	Battery backup operators only.
22	Gate Lock Interlock	See "Table 2. Installer Menu". DG & SG	Locking mechanisms.
23	Emergency Close	Jumper to +24 COM. See OC setting in "Table 2. Installer Menu"	Installer menu enabled and input +24V to trigger. Requires constant hold or supervised input. Overrides photo eyes, gates edges & vehicle detectors.
24	Fire Dept Open	Jumper to +24 COM. See "Table 2. Installer Menu". FO	Installer menu enabled and input +24V to trigger. Overrides photo eyes and gates edges.

SETTING THE EMERGENCY FAST CLOSE

To enable the Emergency Fast Close option on StrongArm Fortified Barrier Arm, you need to program the Smart Touch Controller by taking the following steps:

NOTICE

When you are in programming mode the buttons on the keypad change from Open, Close, and Stop to Previous, Next, and Select. See "Menu Mode Navigation" on page 25.

1. Make sure the operator is turned ON and a Run mode gate status appears on the Smart Touch Controller, which indicates the machine is operational.
2. Press the Menu button twice to access the User Menu.
3. Press and hold the Reset button and then the Open button. Hold the buttons for two seconds and then release both buttons to access the Installer Menu.
4. Press Next until the Emergency Close, OC 0 appears on the display.
5. Press Select and OC starts blinking, which indicates the display can be changed.
6. Press Next or Previous to change the display to OC 1.
7. Press Select to accept the entry. (The display characters stop blinking.)

8. Press Menu to exit programming mode and return to Run mode. A Run mode gate status appears.

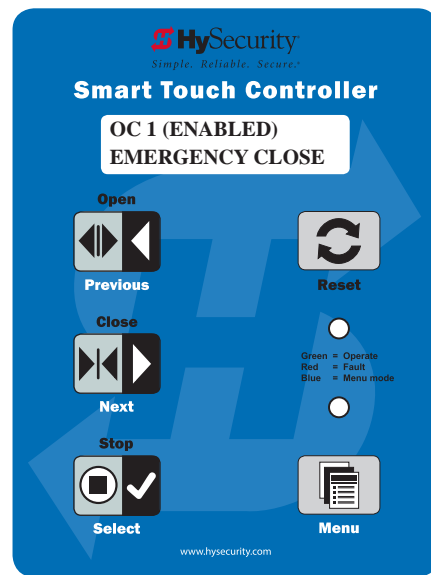

Figure 21. STC Emergency Close

INSTALLING A PUSH-BUTTON DEVICE FOR EFC

The Emergency Fast Close is designed for a constant hold function, such as a push-button device that is held for the duration of barrier arm travel. To operate properly, the device must be connected to Terminal 23 on the Smart Touch Controller and a +24VDC terminal on the red terminal block.

When the connections are made, a constant hold signal transmitted to the Smart Touch Controller causes the Emergency Fast Close function to close the barrier arm at a higher speed than usual, and photo eyes, vehicle loop inputs, and other safety devices are ignored. See Figure 22.

Table 4. Emergency Fast Close Speeds		
Operator	Close Speed	EFO Close
StrongArm M30	6 to 8 seconds	5 to 7 seconds
StrongArm M50	6 to 8 seconds	5 to 7 seconds

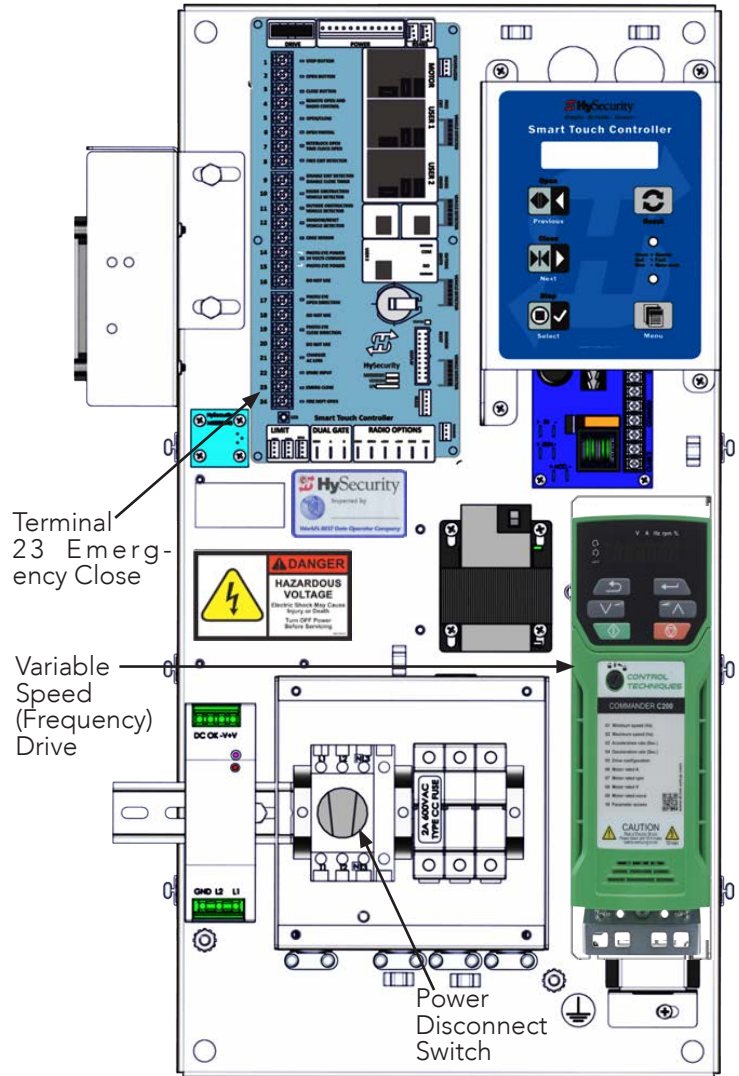

Figure 22. STC Control Board

CONNECTING ACCESSORY DEVICES

Devices, such as gate edge sensors and photoelectric beams, must be installed to protect against entrapment. Most barrier gates are site-specific when it comes to safety standard compliance, and power requirements fall under UL 508A. Always check your local area codes and comply with all regulations.

Standard accessory (entrapment and loop wire) connections are shown in the following illustration. All accessories require a minimum of two connections:

- a device input
- a Common Bus Terminal (COM)

See Figure 23.

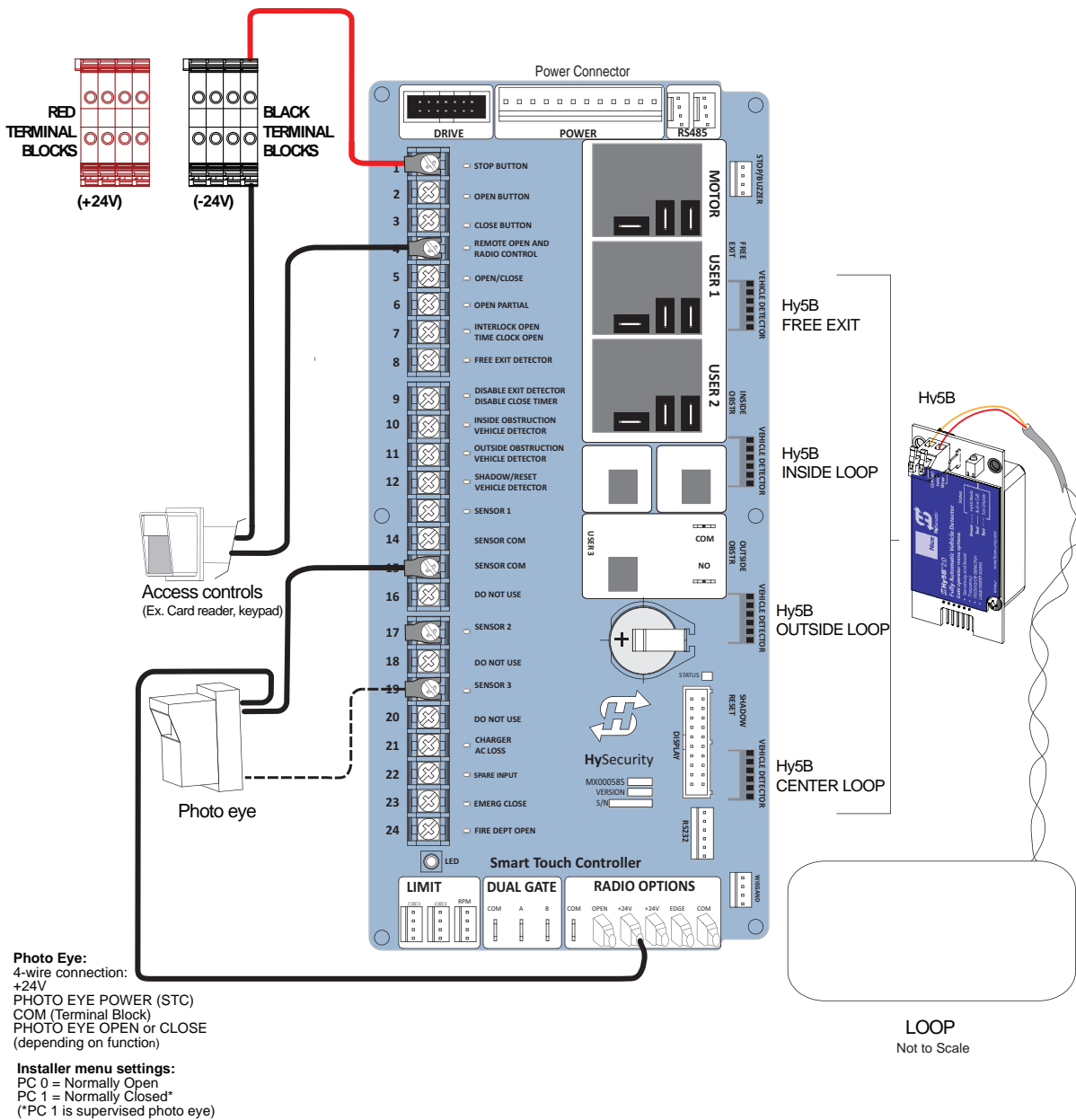

Figure 23. Connecting Accessory Devices

The Smart Touch Controller is able to interface with many types of external devices through the use of three user programmable output relays: two mechanical relays (User 1 and User 2), and one solid state relay (User 3) which is used most often for connection to flashing devices.

All of the user relay functions identified and described in the table below are accessible in the Installer Menu selections.

NOTICE

A setting of zero disables a User Relay. The User Relays will operate normally to 18VDC. Below 18VDC, alert notification occurs. On Crash-rated products User 3 relay is unavailable. It is pre-wired for the

Use the STC buttons to program the user relays according to the following steps:

1. Select the relay you wish to use through the "Installer Menu: Table 2." on page 5-7. For example: RL 1 (RELAY 1 LOGIC) or RL 2 (RELAY 1 LOGIC).
2. Select the appropriate function (1 through 28) by changing the display to the associated number listed in the table. Use the Select, Next and Previous buttons to make your selection. See "Menu Mode Navigation" on page 25.

Table 5. Programmable User Relays

1	Close limit output	Output can be used as an interlock signal to another operator's interlock input, or simply to indicate that the Arm is secure. The relay is "off" when the Arm is closed. The relay energizes when the fully-closed limit is released. (Any open command energizes the relay.)	Relay 1 or 2
2	Close limit pulse output	Used in a sequenced system to command a second machine to close. Generates a brief pulsed output that occurs when the close limit is triggered.	Relay 1 or 2
3	Open limit output	Indicates a full-open position. This output becomes active when an open-limit is triggered and deactivates when the open-limit is released or a close command is received.	Relay 1 or 2
4	Open limit pulse output	Used in a sequenced system to command a second machine to open. Generates a brief pulsed output that occurs when the open limit is triggered.	Relay 1 or 2
5	Warn before/during operate output	Controls an external warning device. This output operates at the same time as the internal warn before operate buzzer.	Relay 1 or 2
6	Arm Lock output	Controls external solenoid or magnetic locks. In both directions of travel, this output is activated about 7/10ths of a second before the operator starts moving the Arm and remains active while moving. Output remains active, for a few seconds, after stopping.	Relay 1 or 2

Table 5. Programmable User Relays

7	Arm forced open output	Activated if the Arm is forced off the closed limit switch and the operator is not able to restore the Arm to full closed position within four seconds. NOTE: This alarm resets itself in 30 seconds.	Relay 1 or 2
8	Arm open too long output	Activates when the Arm is open longer than the userselected period of time. Adjustable from 0 seconds with 15 to 135s selectable delay timeframes in 30s increments. NOTE: TL - Open TIME ALERT adjustments can be made in the Installer Menu. The TL Installer Menu display only appears when using this relay.	Relay 1 or 2
9	Safety Mode Alert output	Activated when the system is in Safety Mode or Entrapment Mode. Safety Mode occurs when the Arm encounters an obstruction. Entrapment Mode means the Arm is stopped and occurs if the internal inherent sensor triggers while the system is in Safety Mode.	Relay 1 or 2
10	Entrapment Mode Alert output	Activated only when in the Entrapment Mode.	Relay 1 or 2
11	Unauthorized Vehicle Entry output (Tail gate alert)	Activated when a second vehicle enters from the outside without a valid input from an access control device. This output releases when an access control input signals open or the arm/gate reaches the close limit.	Relay 1 or 2
12	Outside Obstruction Vehicle Detector output	Interlocks an entry device to prevent pedestrian use. This output is active whenever the Outside Obstruction Loop Detector is tripped.	Relay 1 or 2
13	Loitering Alert	Indicates a vehicle is loitering on the Outside Obstruction Loop. Adjustable from 0 seconds with 15 to 135s selectable delay timeframes in 30s increments. NOTE: LT - LOITERING ALERT adjustments can be made in the Installer Menu. The LT Installer Menu display only appears when using this relay.	Relay 1 or 2
14	Arm nearing full travel output	Applies to operators with position sensors only. Activated when the gate is 3s from expected limit switch trigger. NOTE: If the operator has not yet learned limits, it will energize Relay 14 when the motor begins moving the Arm.	Relay 1 or 2
15	Arm failure output	Activated to report occurrence of a problem. Indicates the system is in an Error Mode, Fault Mode or Entrapment Mode.	Relay 1 or 2
16	Motor Running output	Active when the motor is running and Arm is in motion.	Relay 1 or 2

Table 5. Programmable User Relays

17	AC Power Failure output	This relay is normally energized and drops with loss of AC power.	Relay 1 or 2
18	DC Power Failure output	DC operators only. The relay activates when the battery power is very low, but the output ceases when the battery is dead. The relay is triggered when the battery is less than 20 volts.	Relay 1 or 2
19	Flasher Relay	Flashes lights once per second. The relay is constantly pulsing except when the open limit switch is triggered. * Preferred connection is Relay 3, a solid state relay (except on Crash-rated products). On Crash-rated products, Relay 3 is hard-wired for LED barrier arm lights.	Relay 1 or 2* (Relay 3)
20	Free Exit Loop Vehicle Detector output	Active when the Free Exit Loop is tripped.	Relay 1 or 2
21	Inside Obstruction Vehicle Detector output	Active when the Inside Obstruction loops is tripped.	Relay 1 or 2
22	Reset Loop Detector output	Active when the Reset loop detector is tripped.	Relay 1 or 2
23	External Latching Arm Lock Output	Activates when the Lock Interlock Input (Terminal No. 22) is active at the start of an Open cycle and remains on until the Lock Interlock releases or 10 seconds elapse, whichever happens sooner. Also, activates a Close cycle and releases 1 second after reaching the Close limit.	Relay 1 or 2
24	Arm at Partial Open Position	Not used in StrongArm. Active when the partial open position is reached or exceeded.	Relay 1 or 2
25	DC Power Alert	Deactivates when the software detects a low battery voltage (below 21VDC, but greater than 18VDC) for a duration of 2 seconds or more. To slow battery drain, accessory power loads are shed.	Relay 1 or 2
26	Free Vehicle Detector Pulse	Activates when the Exit Loop Detector is tripped and causes a 250mS pulse output to occur.	Relay 1 or 2
27	Not Open (requires AC power)	When AC power is detected, this relay activates when the gate is NOT on the open limit. If AC power fails, or the gate is on the open limit, the relay is deactivated.	Relay 1 or 2
28	Flasher (requires AC power)	Controls flashing lights that pulse 500ms per second. The relay is constantly activating except when the open limit switch is triggered or AC power fails.	Relay 1 or 2

STRONGARM M30/M50 VEHICLE LOOP REQUIREMENTS

To enable automatic gate closure after a vehicle proceeds through, the StrongArm M30/M50 operator requires, at minimum, two vehicle loops:

- 1 obstruction loop (inside or outside)
- 1 reset loop

The reset loop must be centered directly under the arm with consideration regarding the required loop dimensions for the clear opening. The obstruction loop must be placed so that a vehicle will be capable of tripping both the reset and obstruction detectors simultaneously, which will initiate a close command. See Figure 24.

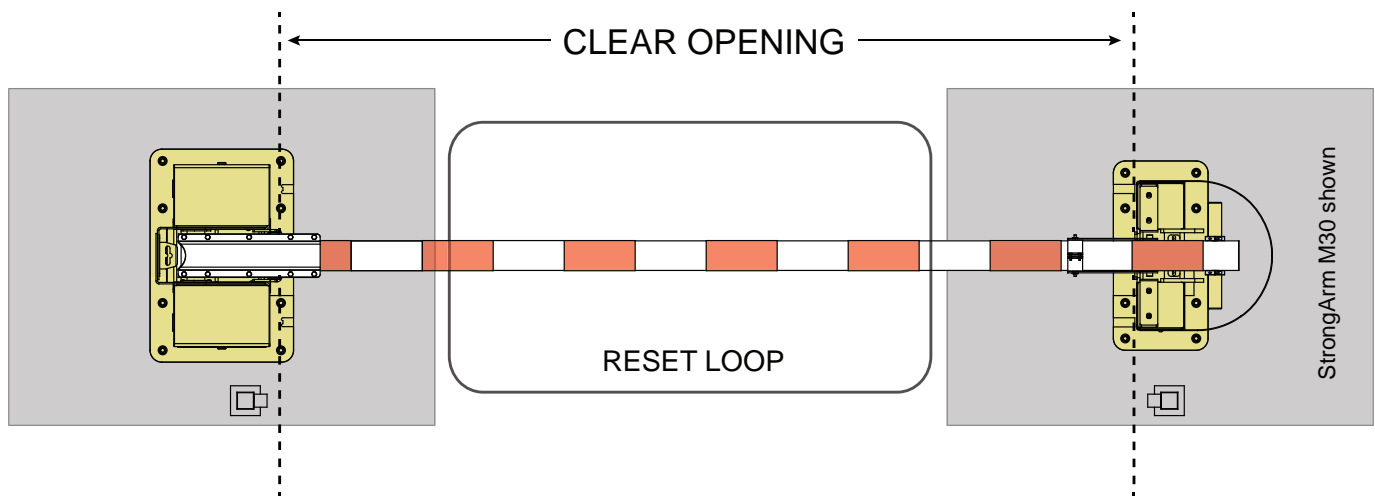

Figure 24. StrongArm Clear Opening

CAUTION

Due to safety considerations and the mass and speed of the Fortified Barrier Arms, it is recommended that three vehicle loops be installed with HySecurity StrongArm M30 or StrongArm M50 Barrier Arms.

- If the gate is to be manually controlled with a pushbutton, only one Reset loop, centered under the arm is recommended. However, the addition of Outside and Inside Obstructions Loops will improve vehicle detection and reduce the risk that user inattention or excessive vehicle speed could result in a vehicle hit.
- If automatic gate closure is desired and the gate is only used for one way traffic, a Reset Loop and at least one Obstruction Loop is required. To reduce tailgating, the Obstruction Loop should be placed so that it is triggered 2nd in sequence as the vehicle travels through the gate. If automatic closure is desired and the gate is to be used for bidirectional traffic, one Reset Loop and two Obstruction Loops are recommended. The obstruction loop must be placed so that a vehicle is capable of tripping both the reset and obstruction detectors simultaneously, which will initiate a close command. Refer to the diagram below.

NOTICE

If tailgating is a concern, reduce dimension D. Dimension B, on all loops, may also be reduced to 4 feet (122 cm) minimum, however detection of high bed vehicles will be impaired. Refer to the "X" and "H" dimensions shown below. The Smart Touch Controller has three available settings when an Obstruction Loop is tripped during closure: Reverse open, pause only, continue closing.

StrongArm M30/M50 Fortified Crash-Rated Barrier Arm

Vehicle Loop Layout : Single or Bi-directional Traffic

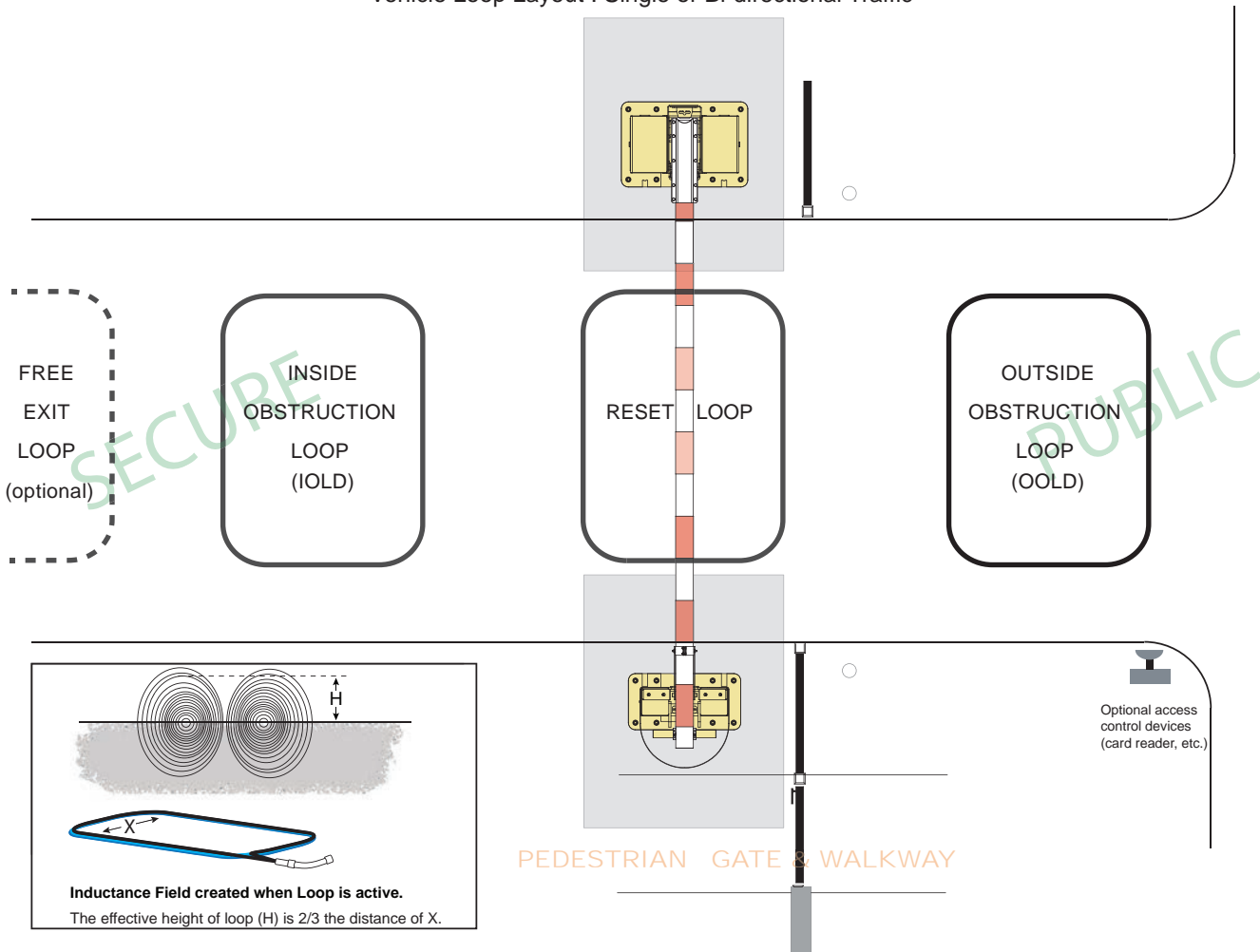

Figure 25. Single/Bi-Directional Traffic Loop Layout

VEHICLE DETECTOR INSTALLATION: HY5B

The Smart Touch Controller provides an interface for up to four different vehicle detector functions.

Standard box type 11 pin (24 VDC or 24 VAC) vehicle detectors may be connected in the traditional manner, but HySecurity's custom Hy5B mini-detector module plugs directly into the Smart Touch Controller, making field installation much faster and enhancing performance. The detector communicates with the Smart Touch Controller microprocessor to achieve the following benefits over common box type detectors:

- Loop frequency is automatically set and monitored by the Smart Touch Controller.
- Best operating frequency for each loop is automatically selected.
- Cross-talk between multiple loops is impossible.
- Very low power draw, which is important for maximum UPS capability during a power failure or for solar applications.
- Loop frequency and call strength can be reported on the Smart Touch Controller display.
- Loop malfunctions are stored by the Smart Touch Controller and appear in code on the display.

NOTICE

It is not mandatory to use two separate detectors for inner and outer obstruction detection; however, the benefits of using the additional Hy5B detector are great. Several new features are possible, such as second vehicle tailgating detection, loitering alert, and selectable non-reversing options.

Four vehicle detector inputs (terminals: 8, 10, 11, and 12) exist on the Smart Touch Controller, as well as the four direct plug ins for the Hy5B modules. See "Overview of the STC and Power Module" on page 45.

The vehicle detector input functions are as follows:

- Free Exit Loop Detector - Opens a fully closed gate.
- Outside Obstruction Loop Detector (Out Obs Loop) - Triggered by the outside (public side) vehicle detector loop
- Inside Obstruction Loop Detector (In Obs Loop) - Triggered by the inside (secure side) vehicle detector loop
- Center/Reset/Shadow Loop Detector - On barrier arm gates, prevents closure when active. On swing gates, prevents gate from opening or closing when the vehicle detector is active.

NOTICE

Use of any combination of Hy5B detectors and box detectors is acceptable. On occasion, multiple obstruction detectors may be mandatory. For example, an area greater than 200 square feet (61 square meters) of vehicle loop cannot be connected to any one detector because the sensitivity becomes inadequate. Refer to "Appendix C - Loop Design" on page 97.

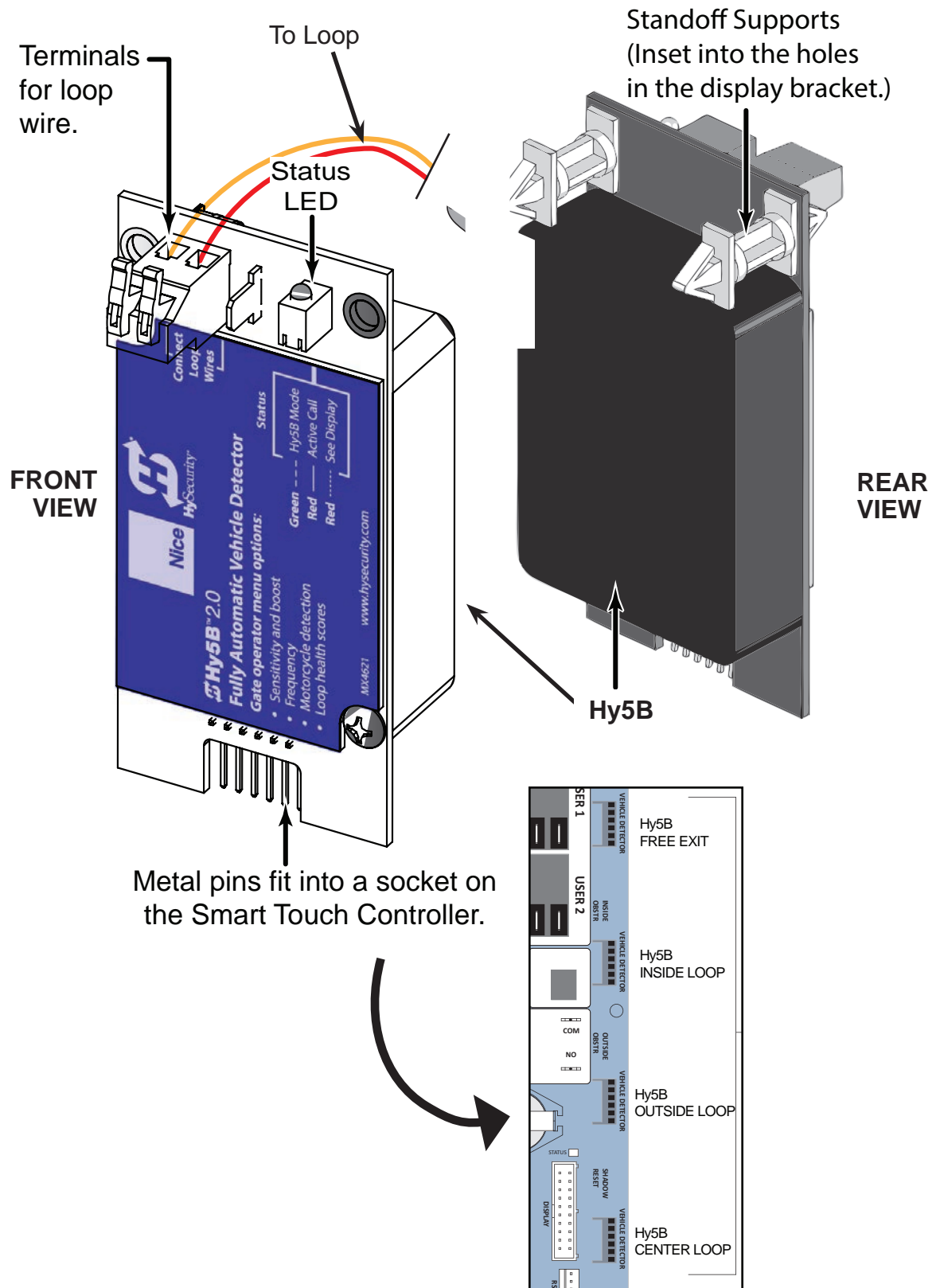

Figure 26. Hy5B Vehicle Detector Module

CONNECTING HY5B VEHICLE DETECTORS

NOTICE

Refer to the installation instructions provided with the Hy5B vehicle detectors. It provides detailed illustrations and instructions that are not found in the steps below.

A quick overview on how to install the Hy5B Vehicle Detector modules, one at a time, follows:

1. Turn off the AC power switch on the Control Box.
2. Insert the locking end of the two white plastic standoffs into the mounting holes on the detector. See Figure 27.
3. Plug the detector into the appropriate socket along the right edge of the Smart Touch Controller. Be careful to align the six detector pins into the socket correctly (the loop terminals should face toward the board), and then snap the standoffs into the holes in display bracket.
4. Route the loop wires through the chassis so they do not move and connect the loop leads to the two terminals on the Hy5B detector.

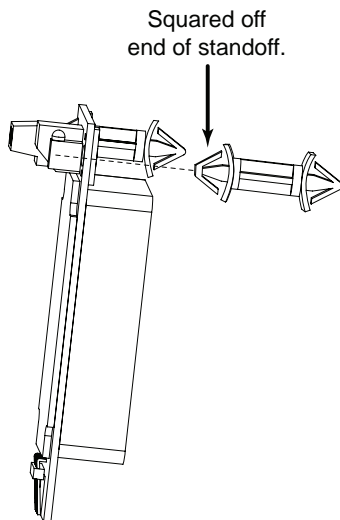

Figure 27. Vehicle Dectector Standoff

5. To enable the detector, turn on power. The detector will immediately tune if it is connected to a vehicle loop. Make sure no cars or other metal objects are over the loop.

6. Repeat Steps 1 through 5 for each Hy5B detector.
7. Cycle the barrier two times to allow the detectors to 'LEARN' the environment.
8. If the detector module is unplugged after it is enabled, a communications alert (ALERT 10) will be triggered. If the fault is not resolved, an error message, ERROR 3 "Detector Failed" is displayed.

NOTICE

If there is any detector fault, the gate operator functions as if the detector is triggered.

Pressing the RESET button:

- ◆ Clears any errors
 - ◆ Tunes the detectors on connected loops
 - ◆ Un-installs any detectors that have been removed
9. The Smart Touch Controller automatically governs frequency selection for all Hy5B detector modules. This simplifies installation and guarantees that there is no cross-talk between multiple loops. The frequency and call level can also be manually selected; if this is required, refer to the appropriate loop set in the "Table 2. Installer Menu".

NOTICE

Do not exceed more than 200 square feet (61 square meters) of loop area to one detector.

10. The Hy5B automatically adjusts sensitivity. If satisfactory results cannot be obtained, one can go into the menu on the STC and manually set the sensitivity.

PHOTO EYES (NON-CONTACT) INSTALLATION

An integrated photo eye is standard equipment on the StrongArm M30 and StrongArm M50 operators. It is wired and requires low voltage conduit to the catch post. If your site conditions require a battery-powered transmitter, it can be ordered through your distributor.

Understand your site requirements and use the layout diagrams available in the appendix to determine the most appropriate mounting positions for any additional photo eyes. The Smart Touch Controller has three sensor inputs (Sensor 1, 2, 3).

The two common photoelectric sensor types are thru-beam and retro-reflective; each has its advantages. A thru-beam sensor is generally more powerful and able to function more reliably with dirty optics and in poor weather. A retro-reflective sensor has the convenience of not requiring the installation and electrical wiring of the remote emitter required in a thru beam system, but is generally less reliable in poor weather.

NOTICE

Avoid using a retro-reflective device to span a distance greater than 24 feet (7.3 meters) in an outdoor environment because of reduced performance.

Compatibility

The UL 325 standard requires that a photoelectric sensor be laboratory tested and "recognized" under UL 325. In order to be compatible with all HySecurity operators, a photo eye must be rated to function from 24 Volts DC source power.

Installation

Install additional photo eyes according to the following steps.

1. Locate the photo eye approximately 15 to 30 inches (38 to 76 cm) above the ground and as close to the gate as possible. See site layout below.
2. Mount the receivers on the left or right side of the gate operator.
3. Mount the emitters just beyond the travel of the arm in the fully-closed position.

NOTICE

The installation locations described above are intended for pedestrian detection. If photo eyes are also to be used for vehicular detection, consider (in addition to the low elevation photo eye for cars) installing another photo eye at a height of about 55 inches (140 cm) to detect semi (tractor-trailer) trucks.

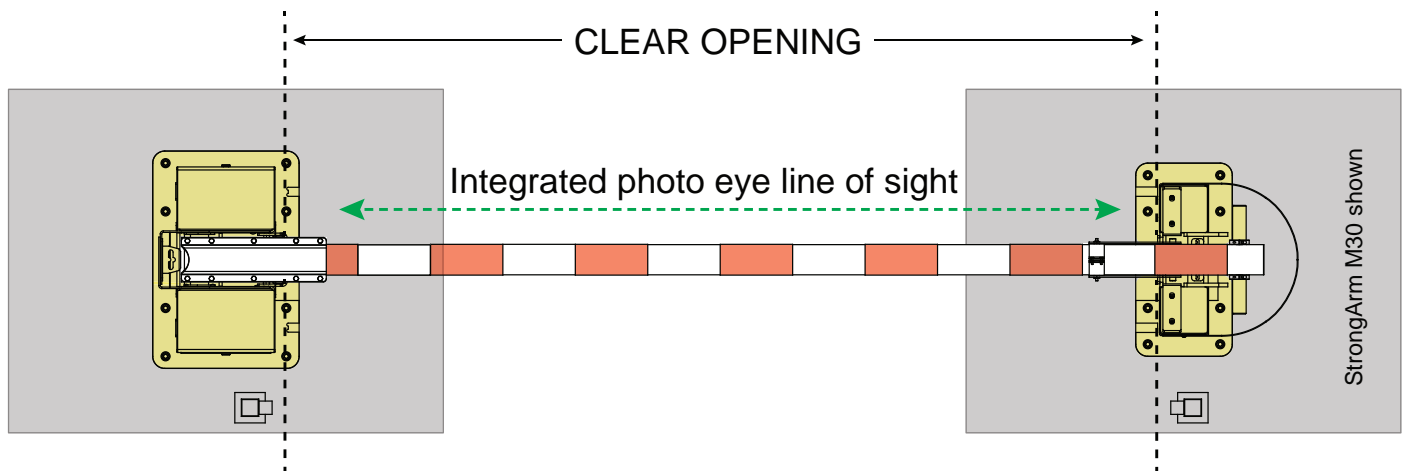

Figure 28. Photo Eye Installation

Configuration

Configure the photo eyes according to the following procedure.

1. If the photo eye has an internal switch for setting Light Operate versus Dark Operate, select Light Operate.
2. If the photo eye has a relay output and has both NO and NC terminals, some experimentation may be required to determine the proper connection because, when its in the Light Operate mode, the output relay is normally energized and releases when the beam is blocked.

Some manufacturers label an output as NO, when it is actually an NC contact.

If the photo eye has a solid-state output, you must choose a sinking-type connection.

Photo Eye Connections

The StrongArm M30/M50 contains an integrated photo eye, the transmitter of which is in the Catch Post, and the receiver of which is in the Pivot Post. The receiver is pre-wired at the factory, but the transmitter will have to be powered by connecting the power and common wires to the +24V and Common terminals on the Power Supply Module as shown in Figure 29.

If additional phot eyes are desired they may be added as follows:

1. Obtain the +24V and common to power the transmitter from the red terminal block.
2. Land both the Common and the negative power wire for the receiver on terminal 14 or 15, Sensor Com.
3. Land the NC Connection from the receiver on terminal 19, Sensor 3.
4. Enter the Installer Menu, and proceed to Sensor 2. Change this option to 2 - Eye Close.
5. Exit the Installer Menu, and test the operation of the photo eye by cycling the barrier and ensuring that:
 - a. the barrier responds to a Close command; and
 - b. blocking the photo eye while the barrier is closing results in it stopping or reversing.

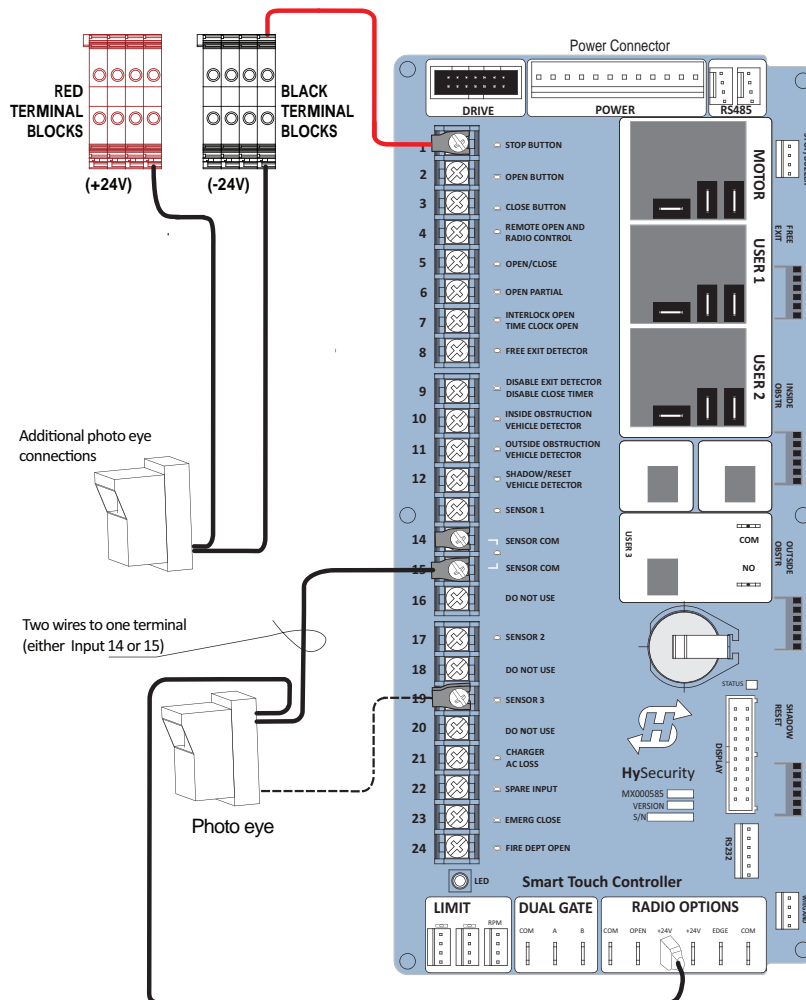

Figure 29. Photo Eye Connections

Photo Eye Alignment

Photo eyes require careful optical alignment in order to aim the emitter beam to the center of the receiver or reflector. In order to avoid false triggering, it is important to carefully align the system, especially with retroreflective photoelectric sensors. To that end, HySecurity has provided a unique feature that turns power on to the photo eyes and causes a buzzer to chirp when the photo eye enters and exits alignment. Align the photo eyes using this feature by taking the following steps:

1. Refer to "User Menu: Table 1." on page 5-4.
2. Move the barrier arm off (away from) the close limit.
3. Set the menu item [PE_0] to [PE_1] .
4. Start aligning the photo eyes; the buzzer will chirp once when the beam is broken and twice when remade. (The parameter will automatically reset the next time the Close Limit Switch is triggered.)

Monitored Connection

The photo eye integrated into the pivot and catch posts has a true NC output (one that is NC when the photo eye is powered, aligned and set for Light Operate). It is a "monitored connection." A monitored connection tests for the presence and correct operation of the photo eye prior to each gate activation and prevents gate operation if any fault is present. The Installer Menu item, PC 1 must be changed to PC 0 to disable this feature.

Photo Eye Function

If the gate is stationary, a tripped photo eye will prevent the gate from starting in either direction. If tripped while in motion, the standard function is to pause the gate motion and then automatically restart again if the photo eye is clear within five seconds. An optional setting in the Installer Menu will cause a full open reversal of travel. See EC in "Table 2. Installer Menu" on page 34.

DUAL GATE SYSTEMS

Configuring two or more operators to work together as an interlocked pair (Master/Second or Sally Port) or sequenced gate system is easy to do with the Smart Touch Controller. There is no need to order a special model or any adapters. The area of the board marked Dual Gate employs a 3-wire RS-485 serial port for communication between the operators. Refer to note and the wiring diagram below to connect both interlocking and sequenced gates. See Figure 30.

RS-485 remote communication is available for networked security systems. See page 46 for additional information.

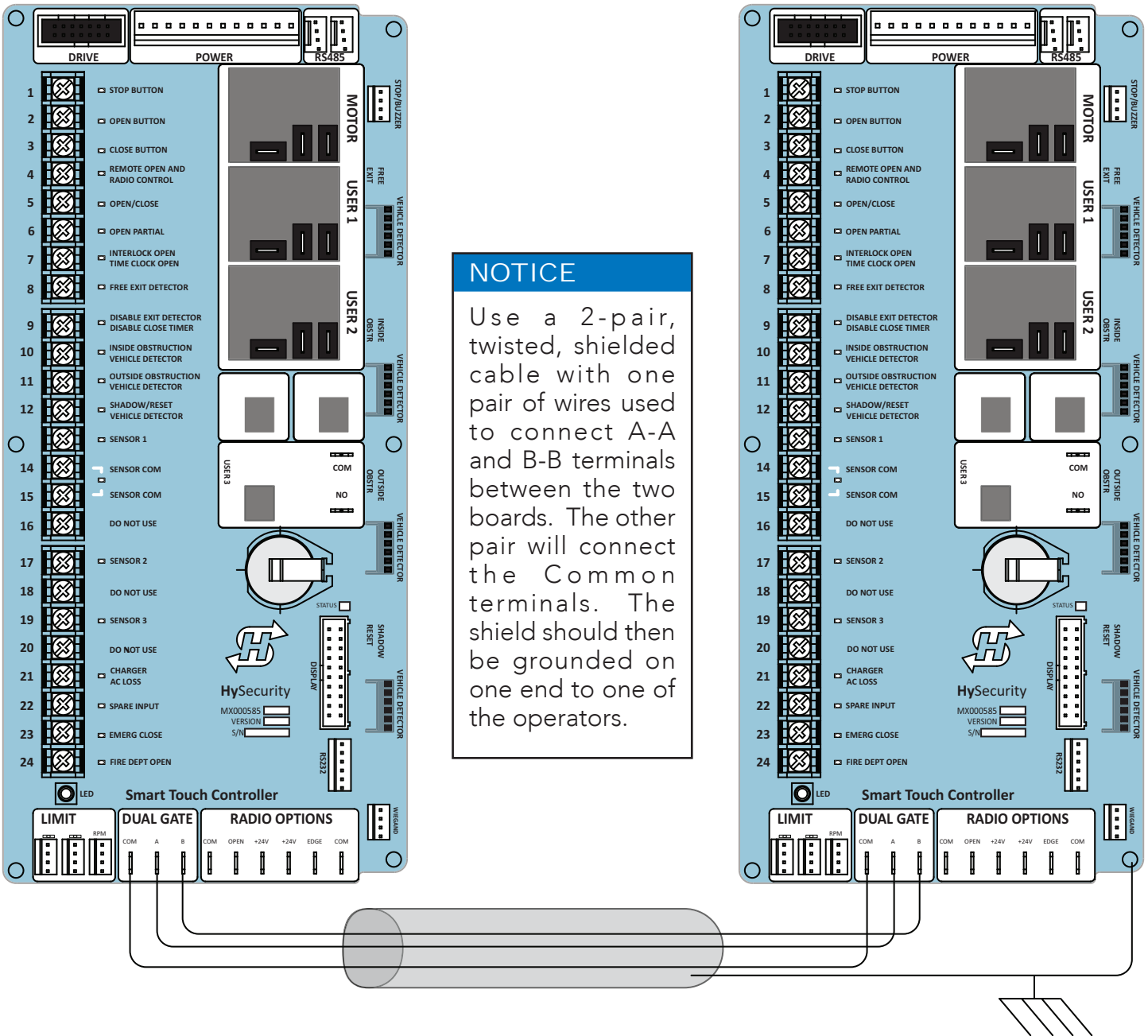

Figure 30. Dual Gate Wiring

CONNECTING AN INTERLOCKED PAIR (DUAL GATE)

The Smart Touch Controller (STC) provides dual gate connections and programming features to connect a pair of gate operators in a Master/Second or interlocked Sally Port configuration. The STC software establishes the communication protocols when wiring the two gate operators. A Master/Second pair of operators can be set for different open/close timing sequences and Sally Port gates are often used at correctional facilities. In Sally Port configurations, one operator cannot open unless the other is fully closed. To learn how to connect the wiring between operators, review the wire diagram on the next page.

NOTICE

The operators do not have to be of the same type, but both need to have the most current and up-to-date software version installed on the Smart Touch Controller. A StrongArm M30/M50 can be interlocked with a SlideDriver™ to provide both Crash-rated protection and personnel security. The STC software integrates seamlessly between operators. See site designs in "Appendix C - Loop Design" on page 97.

Dual Gate Wiring Connections

To connect an interlocked pair of gate operators, simply follow the steps below.

1. As shown in the Wire Diagram, connect a shielded communications cable to the DUAL GATE inputs in each operator. The inputs are located near the base of the Smart Touch Controller. Be sure to connect the wires in pairs to the same terminal ports (A-A, B-B, COM-COM) on both operators.
2. Attach a ring terminal to the shield wire and connect it to the Smart Touch Controller's convenient ground screw.

CAUTION

Each gate operator is built to run on a specific line power voltage and phase. Failure to ensure the source voltage, phase and frequency match that is specified for the equipment may result in severe damage to the equipment.

Dual or Sequenced Gates: Power, Software & Accessory Requirements

When installing an interlocked pair, the following must be adhered to:

- An electrical conduit for interconnecting wires must span between the two operators. The interlock (dual gate) communication wires and any low voltage control wires must be installed in a conduit that is separate from the high voltage power cables.
- Complete the installation of both operators as separate machines and verify that their basic functions are correct as solo operators before interconnecting them.
- Be sure both operators are running the same software. The software version can be viewed on the display by pressing the RESET button. For example: *h 4.31* ("h" = Hysecurity, "4.31" = software version).
- Keep the most current software loaded. It is available at support.hysecurity.com. Make it part of your maintenance routine to check for and install software updates on a regular basis. External control inputs (vehicle detectors and entrapment protection sensors) may be connected to either gate operator in a Master/Second configuration, but in a Sally Port configuration, the external control inputs must be connected to Sally Port A. (Sally Port A being the first gate to open for incoming traffic. Be sure to designate Sally Port A in the dual gate menu item as 3 (*d9 3*) and Sally Port B as 4 (*d9 4*).

Programming a Dual Gate (Interlocked Pair)

Both gate operators must be programmed so they know what function they are to perform as Master and Second or Sally Port A and Sally Port B. (Sally Port A being the first gate to open for incoming traffic.) The Installer Menu provides the Dual Gate (dG) menu item that sets up the functionality of the gate operators. Access this menu item by taking the following steps: See Figure 31.

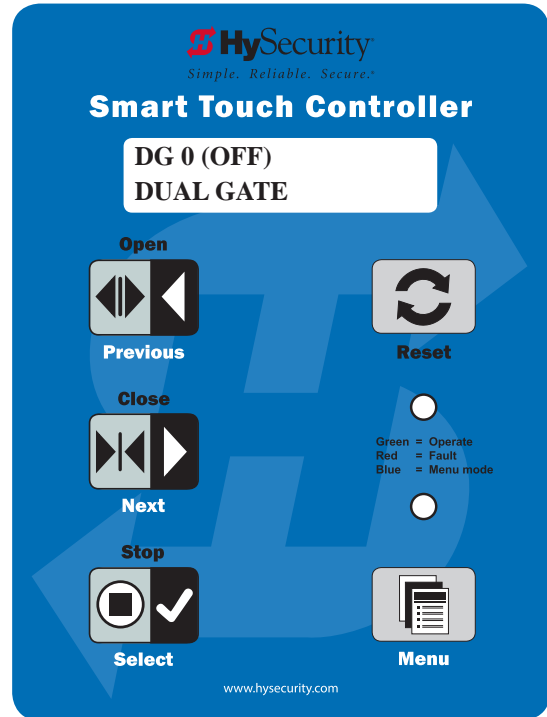
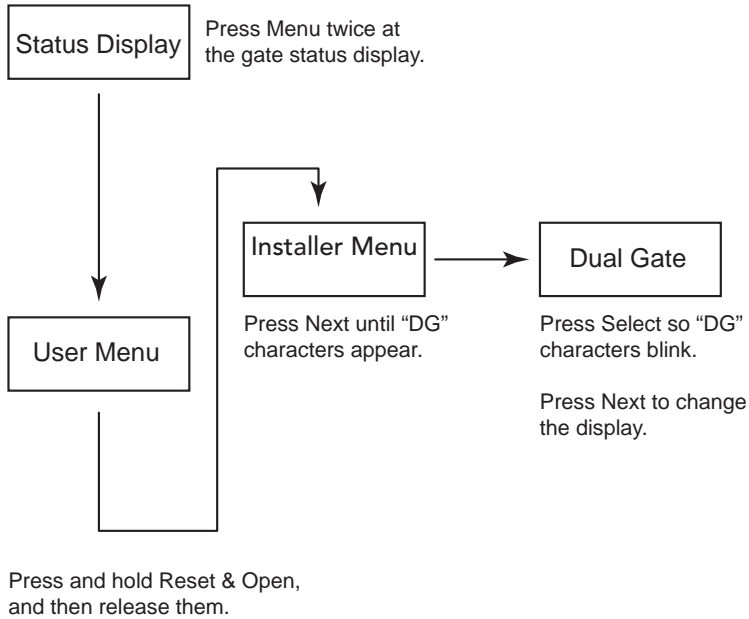

Figure 31. Dual Gate (Interlocked Pair) Menu Layout

Refer to Table 6 to set the operator's functionality.**

Table 6. Dual Gate (Interlocked Pair) Operator Functionality		
**Interlocked Gate type	Operator 1 (Master)	Operator 2 (Second)
Sally Port	<ol style="list-style-type: none"> 1. Press Next until DG 3 appears on the display. 2. Press Select to establish the operator as Sally Port A. 	<ol style="list-style-type: none"> 1. Press Next until DG 4 appears on the display. 2. Press Select to establish the operator as Sally Port B.
Master / Second	<ol style="list-style-type: none"> 1. Press Next until DG 2 appears on the display. 2. Press Select to establish the operator as Master. 	<ol style="list-style-type: none"> 1. Press Next until DG 1 appears on the display. 2. Press Select to establish the operator as Second.

CONNECTING SEQUENCED GATES

Sequenced gates are slightly different than dual or interlocked gates. When two gate operators are connected as sequenced gates, a faster “Traffic Control Gate” operator (i.e. barrier arm or wedge) and a slower “Security Gate” operator (slide, swing, or vertical lift gate) operate in sequence to help prevent tailgating by unauthorized vehicles. Both operators open (Security Gate first followed by the Traffic Control Gate) and allow a vehicle through, but the faster moving Traffic Control Gate closes quickly once its reset/center loop is cleared and all obstruction loops cleared. Upon reaching its closed limit, the Traffic Control Gate signals the Security Gate to close. Note that all shared vehicle detector loops must be cleared before the Security Gate closes.

NOTICE

An emergency open or close overrides the gate sequencing and acts upon both gates simultaneously.

The Smart Touch Controller (STC) provides the sequenced gate connections and programming features, and the STC software establishes the communication protocols when wiring the sequenced gate operators. To learn how to connect the wiring between operators, review the Wire Diagram below.

CAUTION

The operators do not have to be of the same type, but both need to have the most current and up-to-date software version installed on the Smart Touch Controller. A StrongArm M30/M50 can be sequenced with a SlideDriver to provide both Crash-rated protection and personnel security. The inherent STC software integrates seamlessly between operators and software protocols and allows RS-485 communication for networked security systems. See page 6-3 for additional information.

1. As shown in the Wire Diagram on page 64, connect a shielded communications cable to the DUAL GATE inputs in each operator. The inputs are located near the base of the Smart Touch Controller. Be sure to connect the wires in pairs to the same terminal ports (A-A, B-B, COM-COM) on both operators.
2. Attach a ring terminal to the shield wire and connect it to the Smart Touch Controller’s convenient ground screw.

NOTICE

Connect the ground shield wire to only one operator, not both. Use only 18-20 gauge twisted and shielded triple wire.

Sequenced gates are very similar to dual gates (interlocked pair) in their Power, Software, and Accessory Requirements. To review the installation site requirements, refer to page 65. See Figure 32.

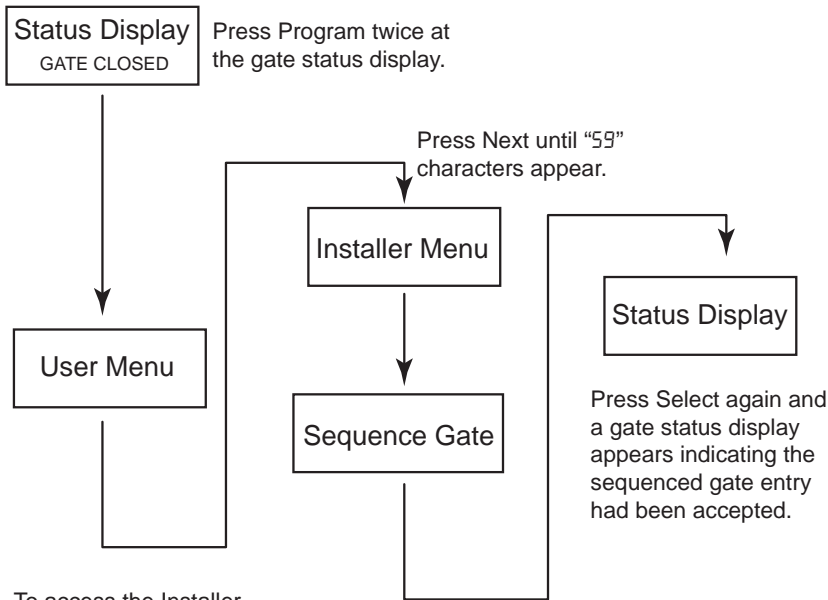

To access the Installer Menu, press and hold Reset & Open, and then release them.

Press Select so "59" characters blink.

Press Next to change the display:

SG 1 = Sequential Gate #1 configuration

SG 2 = Sequential Gate #2 configuration

NOTE: Set both operators on the site to the same number. See the site designs on the following pages.

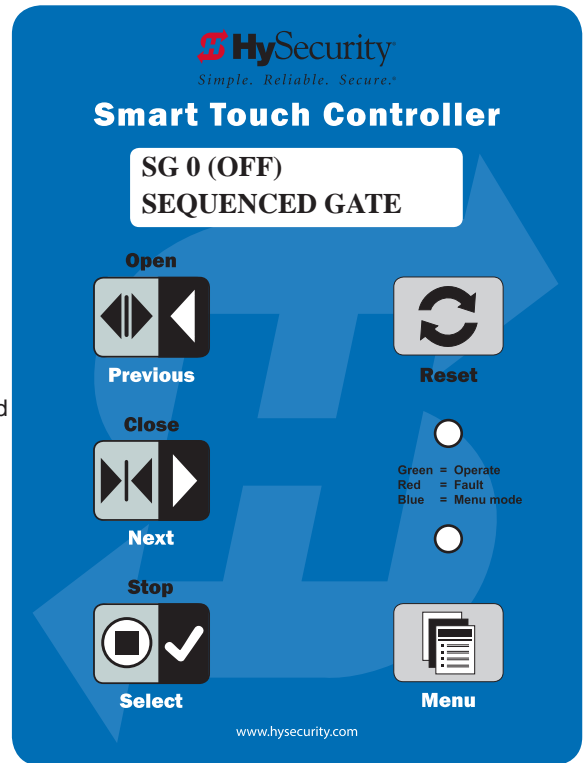
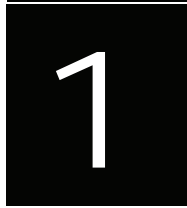

Figure 32. Dual Gate (Sequenced Gate) Menu Layout

Sequential Gate #1

StrongArm M30/M50 with Slide Gate

Site Diagram



Configuration steps:

1. Set the Installer Menu item SG (Sequenced Gate) to "1" in both gate operators.**
2. Set the Installer Menu item CT (Close Timer) as desired.

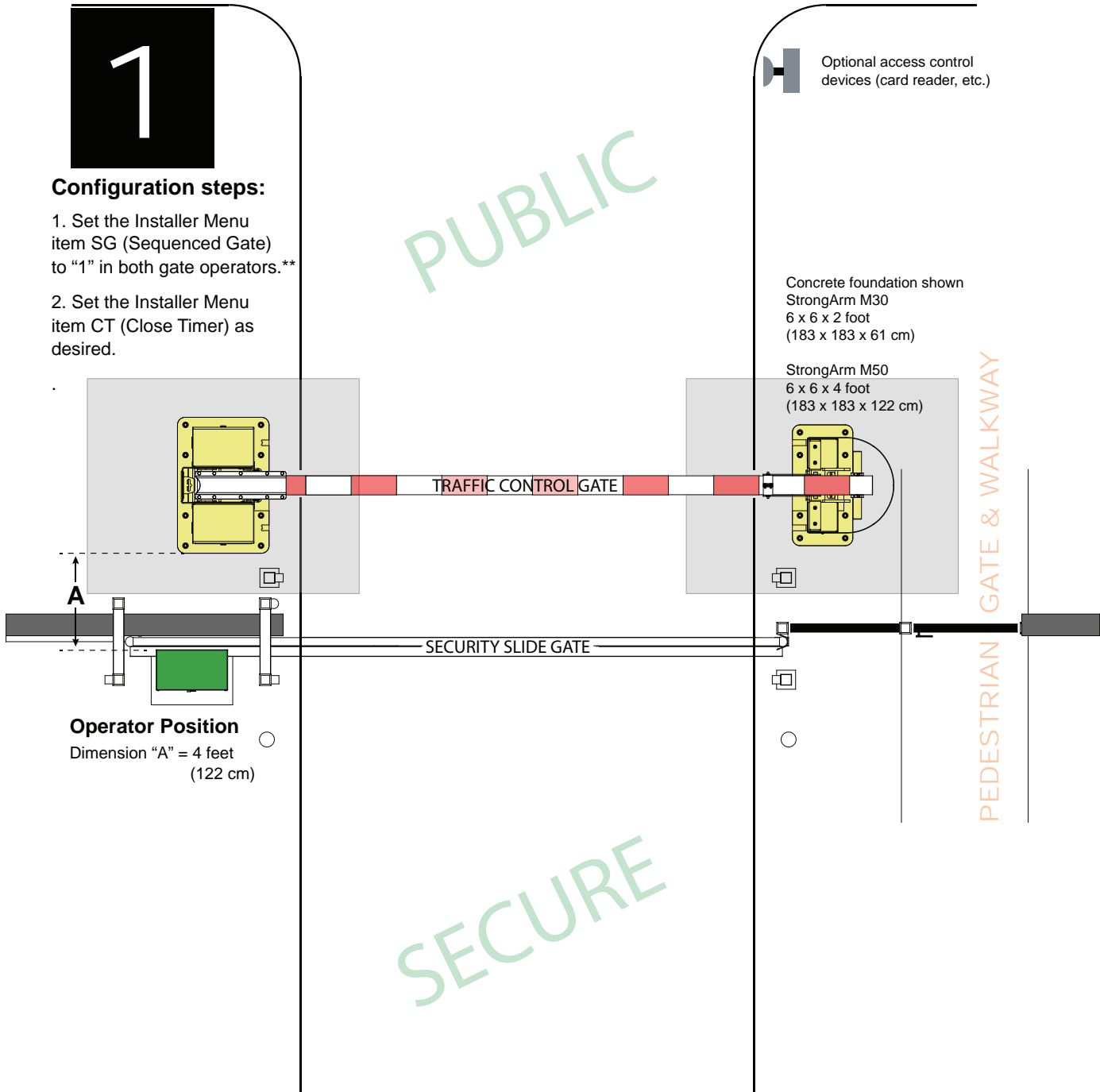

****NOTICE:**

For sequenced gates to operate properly, all vehicle detectors must be wired to the Traffic Control Gate.

If a communication failure occurs, an **AL 22** (Alert 22) appears and the buzzer sounds.

The Traffic Control Gate maintains functionality while the Security Gate defaults to open until communication is restored (or the Security Gate is manually closed).

Drawings are not to scale. © 2012

Sequential Gate #2 StrongArm M30/M50 with Slide Gate

Site Diagram

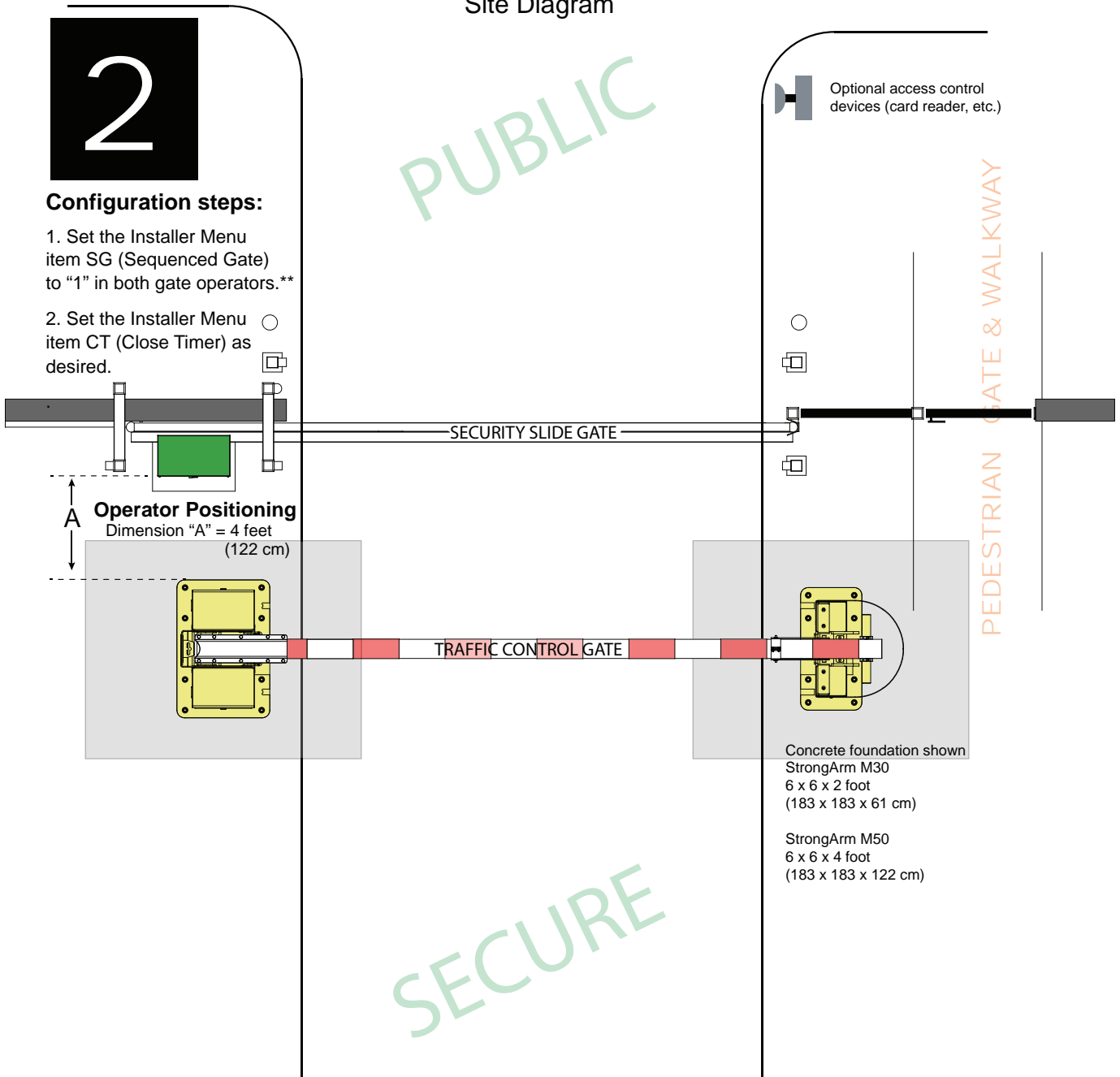

****NOTICE:**

For sequenced gates to operate properly, all vehicle detectors must be wired to the Traffic Control Gate.

If a communication failure occurs, an *Alert 22* (Alert 22) appears and the buzzer sounds.

The Traffic Control Gate maintains functionality while the Security Gate defaults to open until communication is restored (or the Security Gate is manually closed).

Drawings are not to scale. © 2012

The Smart Touch Controller reports system malfunctions (Figure 33) using three simultaneously occurring methods:

- Codes presented on its display (alert, fault or error)
- Activation of a buzzer which emits a series of chirps at defined intervals
- Stop gate travel

Refer to "Table 7. Troubleshooting Codes" on page 72 for details concerning identification and description of Alerts, Faults and Errors.

To help in diagnosing a controller board problem, the active status of each input on the Smart Touch Controller is indicated by its associated LED. See Figure 33.

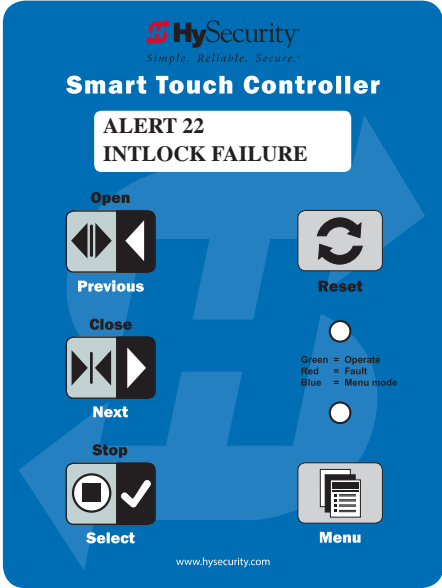

Figure 33. Interlock Failure Screen

NOTICE

A qualified technician may troubleshoot the operator with the aid of the information and procedures that follow. If it is necessary to call a distributor for assistance, be sure to have the model and serial numbers available. Other helpful information is the job name, approximate installation date, and service and records of any recently-performed maintenance work.

SYSTEM DIAGNOSTIC MESSAGES

7 Segment Code	Description	Priority	How to clear
<i>ALE</i>	ALERT	Low	Enter new command such as Open or Close.
<i>FAL</i>	FAULT	Medium	Press the Stop or Reset button
<i>Err</i>	ERROR	High Serious issue that may require technical service.	Errors can only be cleared by pushing the Reset button or cycling power.

NOTICE

The green LED near the coin-sized battery on the Smart Touch Controller is the "heartbeat" of the processor. This LED flashes continuously and at a constant rate when the system is operating normally. When a fault, error, or alert occurs, it turns red.

The Smart Touch Controller maintains self-diagnostics. Specific codes appear on the display and the Audio Alert buzzer emits distinctive chirping sounds. Any Alert, Fault, or Error is logged into memory and date and time stamped. These diagnostic messages can be retrieved for analysis purposes via optional S.T.A.R.T. software.

NOTICE

S.T.A.R.T. configuration and diagnostic software is available at no charge from support.hysecurity.com.

Table 7. Troubleshooting Codes

Display Code (7 Segment)	Error/Fault/Alert Display Description	Buzzer Chirp Sequence	Possible Cause & Suggested Corrective Action
<i>Entr</i>	Entrapment Mode	2 chirps per second every 2s while control input is active	An emergency close with constant hold or an emergency open has caused the entrapment code to appear. When a command of this nature is received, the operator stops and moves into ENTR mode. Clear the code and return to run mode operation, by pressing the Reset button.
<i>SAFE</i>	Safety Mode Alert	2 chirps once when in Safe Mode	An arm “edge” has been tripped or the operator has exited entrapment mode. Refer to the description above. NOTE: Gate will operate, if it receives a RUN command.
<i>Lo24</i>	Low 24V Control Alert (AC or DC)	No chirps; LCD flashes for 1s every 5s	Only occurs in DC powered operators.
<i>bAdP</i>	Critical Low Power (AC or DC)	No chirps: LCD steady and controls disabled	<p>The system monitors the 24V control voltage in lieu of line voltage. Low incoming line voltage will cause low control voltage. Verify that the control transformer is connected properly, (white – not used, red for 208V, orange for 230V and blue for 460 V). Refer to “Control Transformer Connections (Non-UPS)” on page 2-5. Check the line voltage, as the motor starts, with a meter that has min/max hold capability. If the line voltage drops more than 10% below nominal (187 on 208 VAC, 207 on 230 VAC, or 416 on 460 VAC) the voltage is dropping too much and must be corrected. Generally, this requires larger wire size. See “Wire Sizing and Runs” on page B-1. On 3-Phase operators, check each leg of to ground to make sure it is balanced.</p> <p>If the line voltage is not dropping below these limits, check the 24V AC and DC power at the power supply. Voltages less than 20V indicate an overloaded or failing transformer or power supply board. Remove the loads until the fault is found.</p>

Table 7. Troubleshooting Codes

Display Code (7 Segment)	Error/Fault/Alert Display Description	Buzzer Chirp Sequence	Possible Cause & Suggested Corrective Action
<i>LoAC</i>	AC Voltage too Low	2 chirps per second after each close cycle. Display flashes 1s for every 5s	Only occurs in DC powered operators without a solar charger.
<i>dEAd</i>	Dead 24V Battery Alert – DC only	3 chirps upon any operating command entry	DC operators only. Appears when the 24 VDC power drops too low, disabling the operator to prevent damage to the batteries from excessive discharge. Verify the AC power is present at the charger, the charger is on and charging (Red LED is illuminated). charger, the charger is on and charging (Red LED is illuminated). The charger should shut off (Green LED) when the batteries charge to 29.0 VDC. If the batteries will not “hold a charge” replace them.
<i>AL E 1</i>	M30 Arm Forced Open Alert	2 pulses per second for 30s	Set (FA 1) in the User Menu, to enable this option. The operator will attempt to re-close itself if forced off the close limit switch, the buzzer sounds for 30 seconds. Check for attempted unauthorized access, external pressure trying to open the M30/M50 Arm or a mis-adjusted/ failed closed limit switch.
<i>AL E 2</i>	M30 Arm Drift Closed Alert	2 pulses per second for 10 seconds	Set (FO 1) in the User Menu, to enable this option. If a M30/M50 Arm should begin to drift closed it automatically reopens (for up to 4s) once it leaves the full open limit. If it is not back on the open limit at the end of 4s, an audible alert occurs. Check for cylinder leakage, misadjusted/failed open limit, misadjusted brake valve, outside pressure (wind, fallen trees) trying to force the M30/M50 Arm closed.

Table 7. Troubleshooting Codes

Display Code (7 Segment)	Error/Fault/Alert Display Description	Buzzer Chirp Sequence	Possible Cause & Suggested Corrective Action
<i>ALE 4</i>	Motor Thermal Overload Alert	2 chirps per second every 15 seconds	<p>The motor windings have exceeded a preset temperature generally due to excessive current. Verify:</p> <ul style="list-style-type: none"> • The motor connections are correct for the supply voltage • Running voltage is within 10% of rated • High starting currents last 2 seconds or less; if not and voltage during start is correct, on 1Ø units you can replace the start switch/capacitor • Motor running current (all phases) is at or below rated (at normal pressures) • When the motor is cool, open the motor connection box, disconnect the 2 small wires going into the motor, and use an ohmmeter to check continuity of these wires. They should be a short circuit; if not, replace the motor.
<i>ALE 5</i>	Both Limits Tripped Alert	2 chirps per second every 15 seconds	The STC is seeing both limits tripped at the same time. Reset the limits through the Installer Menu's Learn Limits reset.
<i>ALE 6</i>	Limits not released in 5 seconds	2 chirps per second every 15 seconds	Is the pump developing pressure? Are the brake valves set properly? Is there hardware holding the Arm? Check fluid levels and brake valve settings.
<i>ALE 7</i>	Loop Abnormal Frequency Change Alert	2 chirps per second every 15 seconds	Hy5B detector has detected a frequency change outside the normal range. Check the loops and the integrity of the loop installation.
<i>ALE 8</i>	Shorted Loop Alert	2 chirps per second every 15 seconds	Hy5B detector has detected a short circuit in the loop. Temporarily switch detector to be sure the loop is at fault and then repair it.

Table 7. Troubleshooting Codes

Display Code (7 Segment)	Error/Fault/Alert Display Description	Buzzer Chirp Sequence	Possible Cause & Suggested Corrective Action
AL 9	Disconnected Loop Alert	2 chirps per second every 15 seconds	Hy5B detector has sensed that the loop has become an open circuit. Check all connections and/or use an ohmmeter to find out where the break is.
AL 10	Loop Detector Communication Alert	2 chirps per second every 15 seconds	Communication issue between the Hy5B and the Smart Touch controller; reset and try again. Replace the Hy5A if the problem continues.
AL 11	Loop Malfunction Alert	2 chirps per second every 15 seconds	Unknown fault; perform the megaohm test and fix the loop if necessary. Replace the Hy5B if the problem continues.
AL 12	Loop Detector active longer than 5 minutes	2 chirps per second every 15 seconds	<p>The detector believes there has been a vehicle on the loop for greater than 5 minutes.</p> <ul style="list-style-type: none"> • Is there something metal on (or near) the loop? • Is the sensitivity adjustment set too high? • Is the roadway solid? If the underground loop moves it will give false readings. • There may be a problem with the loop itself. Check with a megohm meter. New loops should read 100 megaohms or better, between 50 and 100 operation are generally OK, below 50 meg-ohms install a new loop.
AL 15	Hy5B Loop Detector Communication problem	2 chirps per second every 15 seconds	One or more detectors are not communicating properly. Remove detectors, reset the controller, and re-install detectors one at a time until faulty detector or loop is found.
AL 17	Bad 3V 'coin' battery	2 chirps per second every 15 seconds	Replace the 3V disc battery that controls the internal clock, with the AC power turned off. Use a CR2032 battery.

Table 7. Troubleshooting Codes

Display Code (7 Segment)	Error/Fault/Alert Display Description	Buzzer Chirp Sequence	Possible Cause & Suggested Corrective Action
<i>AL 19</i>	False Slowdown Signal Alert	2 chirps per second every 15 seconds	Not applicable.
<i>AL 20</i>	Lock Interlock (Input #22) Blocks Open	2 chirps per second every 15 seconds	An interlock contact is closed, indicating that the M30 Arm latch (lock) is engaged, preventing the operator from starting. Check the interlock and wiring.
<i>AL 21</i>	VFD Error Alert	2 chirps per second every 15 seconds	M30/M50 Arm travel will not occur until the alert is cleared. Any open or close command resets the alert and starts the M30/M50 Arm moving, unless the VFD is experiencing a fatal error. If you cannot clear the error alert by pressing the open or close button, contact HySecurity.
<i>AL 22</i>	Interlock/Sequential Gate communication lost	2 chirps per second every 3 seconds	Appears when the RS-485 communication connection is lost for more than 5s between interlocked (dual gate) or sequenced gate operators. Check cable connections and wiring. Make sure both operators are working properly and have the same current and up-to-date software versions. The alert auto clears when communication between the two operators is restored. If the operator on site is a singular gate and the display code AL22 appears, access the Installer Menu. Verify the Installer Menu items: DG (Dual Gate) and SG (Sequential Gate) are both set to zero.

Table 7. Troubleshooting Codes

Display Code (7 Segment)	Error/Fault/Alert Display Description	Buzzer Chirp Sequence	Possible Cause & Suggested Corrective Action
<p><i>EL d_</i> <i>00Ld_</i> <i>10Ld_</i> <i>5Ld</i></p>	<p>Vehicle Loop Detectors</p>		<p>Appears in sequence with another display code which pertains to the loop issue. Refer to the other display code for more information.</p> <p>ELD = Exit Loop Detector</p> <p>OOLD = Outside Obstruction Loop Detector</p> <p>OLD = Inside Obstruction Loop Detector</p> <p>SLD = Shadow Loop Detector</p>
<p><i>Err 1</i></p>	<p>Directional Motion Error</p>	<p>3 chirps per second once per minute</p>	<p>Close Limit tripped after running Open or Open Limit tripped after running Closed. Assess cables and wire connections. Make sure wires are connected to the proper terminals.</p>
<p><i>PEC</i></p>	<p>Photo Eye Close</p>	<p>1 chirp indicating that the command cannot be initiated</p>	<p>Operator received command to run, but movement is prevented. Photo eye is blocked or battery is dead. Clear photo eye path and realign photo eye. Replace photo eye battery if needed.</p>
<p><i>PEO</i></p>	<p>Photo Eye Open</p>	<p>1 chirp indicating that the command cannot be initiated</p>	<p>Operator received command to run open, but movement is prevented. Photo eye is blocked or battery is dead. Clear photo eye path and realign photo eye. Replace photo eye battery if needed.</p>
<p><i>9Eb</i></p>	<p>Gate Edge Sensor</p>	<p>1 chirp indicating that the command cannot be initiated</p>	<p>Operator received command to run open, but movement is prevented. Gate edge blocked or disconnected and causes operator to enter SAFE mode.</p>
<p><i>Err2</i></p>	<p>Disconnected IES Error</p>	<p>3 chirps per second once per minute</p>	<p>Not applicable</p>
<p><i>Err3</i></p>	<p>Serial Communication Internal Error</p>	<p>3 chirps per second once per minute</p>	<p>Hy5B detector issue. Press Reset; if problem recurs, replace the detector.</p>

Table 7. Troubleshooting Codes

Display Code (7 Segment)	Error/Fault/Alert Display Description	Buzzer Chirp Sequence	Possible Cause & Suggested Corrective Action
<i>Err4</i>	Serial Communication Master/Second Error	3 chirps per second once per minute	Indicates a problem with the communication between the two gate operators of a Master/Second Set. The software versions of these two operators must be the same. Check the version by cycling the power off and on to each operator. On power up the software version will flash on the screen (example: v4.23). Make sure the conductors are twisted and shielded. Beware of buried high voltage conductors that are too near to the interconnecting conductors, they may interfere. Be sure the parameter (DG) in the installer menu is set to 2 in the Master and 1 in the Second unit. Error automatically clears when communication fault is resolved.
<i>Err5</i>	Internal Communication Error	3 chirps per second once per minute	Replace Smart Touch Controller board - Contact your distributor.
<i>Err6</i>	STC – VFD Communication Error	3 chirps per second once per minute	Internal error between the STC board and the VFD. Check cable connections and wiring. Make sure both units are working properly.
<i>Err7</i>	EEPROM Data Error (factory)	3 chirps per second once per minute	Contact HySecurity.
<i>Err8</i>	PWM Sensor Error (Pulse Width Modulation)	3 chirps per second once per minute	Check wiring from the hydraulic cylinder to the STC.
<i>Err9</i>	EEPROM Data Error (user menu)	3 chirps per second once per minute	Contact HySecurity.
<i>Er 10</i>	Slowdown Switch Failure	3 chirps per second once per minute	Not applicable.
<i>FAL 1</i>	Maximum Run Fault	1 chirp once every 15 seconds	Not applicable to StrongArm M30/M50.

Table 7. Troubleshooting Codes

Display Code (7 Segment)	Error/Fault/Alert Display Description	Buzzer Chirp Sequence	Possible Cause & Suggested Corrective Action
<i>FAL 2</i>	Photo Eye Fault (supervised)	2 chirps per second once per minute	“Supervised” means the STC must see the photo-eye NC contact change from closed to open and back to close after receiving the command to move, but before starting. FAULT 2 indicates the Smart Touch did not see this sequence at start. Be sure the photo-eye is capable of, and set to provide this function. Be sure the eye “common” wire is wired properly to the “Photo Eye Power 24V Common” Terminal and Installer Menu Item 18 (PEO/PEC-NO/NC) is set to 1.
<i>FAL 3</i>	Critical AC sag – bad supply wire	2 chirps per second once per minute	The 24V control voltage is monitored in lieu of line voltage. Low incoming line voltage will cause low control voltage. Verify that the control transformer is connected properly, (white – not used, red for 208V, orange for 230V and blue for 460V). Check the line voltage as the motor starts with a meter that has min/max hold capability. If the line voltage drops more than 10% below nominal (187 on 208VAC, 207 on 230VAC, or 416 on 460VAC) the voltage is dropping too low and must be corrected. This condition is often caused by loose connections or power wiring which is too small. If the wire is too small, it must be replaced. See "Wire Sizing and Runs" on page 95 for proper wire size.
<i>FAL 5</i>	Open/Close Limit Failed (SD50VF only)	2 chirps per second once per minute	Not applicable for StrongArm M30/M50.
<i>FA IL</i>	Program Data Error	3 chirps per second once per minute	1. Try turning off the power to the operator and having the customer re-seat all of the various connectors and cables. 2. Upload the latest software release. If the fail does not go away, REPLACE the STC board.

ELECTRICAL ISSUES

A general set of troubleshooting procedures are provided in the following paragraphs. Use a voltmeter to take the measurements described in the steps. If at any point in the process, a result different than what's expected occurs, stop and identify the problem.

AC-Powered StrongArm M30/M50 Operators

Perform the following:

Verify the incoming voltage and phase at the incoming power terminals on the VFD.

1. Verify the 24VDC power supply has the proper connection to the incoming power.
2. Verify the 24VDC is present at the power supply terminals.
3. Verify that the main power wires are at least the minimum wire size specified in the "Wire Sizing and Runs" on page 95.
4. Verify the 24VDC is present at the +24VDC and common terminals located along the lower edge of the Smart Touch Controller board. (RADIO OPTIONS, etc.)
5. Verify that the "Heart Beat" LED is blinking green.
6. Verify the display is operational on the LCD and VFD display.
7. With the knowledge that the power is correct and the electric motor runs, check the STC display. If an error, alert or fault code appears, refer to "Table 7. Troubleshooting Codes" on page 72 to determine possible resolutions.

MECHANICAL ISSUES

General problems concerning Arm movement can usually be resolved by using the hand pump and manually moving the Arm open and close.

General maintenance recommends scheduled inspection of all fasteners to make sure they are tightened securely and torqued to proper specifications. For torque specs, refer to "General Maintenance".

HYDRAULIC ISSUES

The speed at which the operator moves the Arm is determined by the size of the hydraulic pump and software settings.

CAUTION

Attempting to slow Arm speed by changing a valve setting will cause inefficiency and increased heating of the hydraulic system, which will degrade system performance and also may result in premature system failure.

NOTICE

If the gate speed must be changed, contact your HySecurity distributor or HySecurity Tech Support.

Extremely cold weather is unlikely to seriously affect the Arm speed because HySecurity employs a special grade of hydraulic fluid (Uniflow), which maintains a near constant viscosity over a broad temperature range. This high quality fluid, combined with other design considerations, allows HySecurity to rate its operators for service in ambient temperatures of -40°F to 158°F (-40°C to 70°C).

If the arm speed of your operator has been affected by cold weather, perform the following:

1. Verify the arm hardware is not impaired by ice.
2. Verify that the reservoir is filled with Uniflow fluid.

NOTICE

Consider adding a heater in extreme cold weather regions. A biodegradable fluid option does exist, but it does not have the same fluid viscosity at extremely low temperatures. The biodegradable fluid option has a temperature rating between -10°F and 158°F (-23°C and 70°C).

TYPICAL PROBLEMS AND TROUBLESHOOTING PROCEDURES

A few typical problems and their associated troubleshooting procedures are provided to facilitate identification and resolution.

PROBLEM 1: Pressing the Open and Close buttons produce no response (nothing happens).

1. Verify the line voltage is present and matches the operator's input voltage requirement + 10%.
2. Verify the control voltage is present at the Power Supply Common and 24VDC terminals.
3. If an external Stop button is not used, verify a jumper wire connects Common to Stop.
4. Verify there are no Faults or Errors being reported on the LCD display.
5. Jump COM to the OPEN or CLOSE INPUT and verify that the LED lights on the STC board which indicates that the input is active and working properly. To help in diagnosing the problem, take note of what other inputs light up and check the display for codes.

PROBLEM 2: Hydraulic pump is running and the hydraulic pressure is between 1000 - 1400 PSI on the gauge, but the M30/M50 Arm is not moving.

The VFD Motor Controller displays trip and fault codes. Check to see if any error codes appear on the VFD display. Most VFD issues are resolved through the STC software and modbus interface.

The Smart Touch Controller reports system malfunctions on its LCD display and the buzzer will emit a series of chirps at defined intervals. Review the table of Alerts, Faults and Errors listed in "System Diagnostic Messages" on page 71. To check the status of all inputs on the terminal strip, the LED tact button must be pushed.

If the power is three-phase, verify counter-clockwise Electric Motor rotation. To reverse rotational direction, switch any two AC lines.

1. Check the hydraulic fluid level by removing the plug in the pump reservoir. If necessary, add fluid at this location until the level is about ½ inch below the filler hole.
2. Unplug the hydraulic hoses and run the pump; if the pressure is low, adjust the Pressure Relief Valve.
3. If the Pressure Gauge does not respond to adjustment of the Pressure Relief Valve, completely remove

the valve and depress the plunger at the nose end with a blunt tool (e.g., an Allen wrench) and blow on it to remove any debris.

PROBLEM 3: The arm only opens or only closes.

1. Verify that no external device is commanding the gate to open or close by watching the LEDs associated with each input.
2. If the gate only opens, the Directional Valve is probably stuck and needs to be checked for manual override position or debris.
3. If the gate only closes, the Directional Valve Coil is not being energized or is defective.

PROBLEM 4: All control systems are inoperable.

1. Turn off AC power switch before changing fuse.
2. Use a voltmeter to test the incoming high voltage and outgoing power ports on the fuse module. If either port registers no reading than you will need to change the fuse.
3. To change the fuse, pull up on the tab with the identifying label. Remove and replace the fuse and push the tab down to lock the fuse in place. See illustration in "Fuse Replacement" on page 9-2.

PROBLEM 5: A run command causes PEC to appear on display.

1. Check that the photo eye is not blocked. If it is, remove the blockage and realign the photo eye. See "Photo Eye Alignment" on page 63".
2. If you have a battery-powered integrated photo eye, check that the batteries are viable in the photo eye in the Strong-Arm M30/M50 catch post. If they need replacing, use a 7/32 hex key to remove the access panel from the catch post. Use a phillips head screwdriver to remove the cover from the photo eye and replace the two batteries with lithium AA batteries. Note the polarity on both batteries is in the same direction.
3. Replace the battery cover, place the battery-powered photo eye inside the catch post, and secure the access panel.
4. If needed, realign the photo eye. See "Photo Eye Alignment" on page 63".

HAND PUMP OPERATION

A hand pump is available to manually operate the hydraulic mechanism that secures the barrier arm. In the event of a power failure, manual operation is achieved by accessing the hydraulics section of the pivot post. Follow the steps below to open or close the barrier arm:

CAUTION

Before attempting a manual release, make sure the barrier arm is not in motion and power is unavailable or disconnected (turned off).

Open the Barrier Arm

1. Remove the hydraulics cover panel from the pivot post. See Figure 34.
2. Locate the hand pump and place the handle on its stub. See Figure 35.
3. Firmly, pull and twist the knurled knob a 1/4 turn counterclockwise to release the knob so that it remains in the open position.

NOTICE

If the valve reseats itself, repeat the pull and twist in the opposite direction until the valve remains open.

4. Begin pumping the handle up and down. As hydraulic fluid is pumped into the cylinder, it begins to raise the arm.
5. Continue pumping until the barrier arm reaches full open (vertical) position.
6. Turn the knurled knob so it springs back to the closed position.

Close the Barrier Arm

1. Remove the cover panel from the hydraulics section of the pivot post. See Figure 34.
2. Place the handle on the manual hand pump, check that the knurled knob is in the closed position. Begin pumping the handle up and down. See Figure 35.
3. Continue pumping until the arm reaches full closed (horizontal) position.

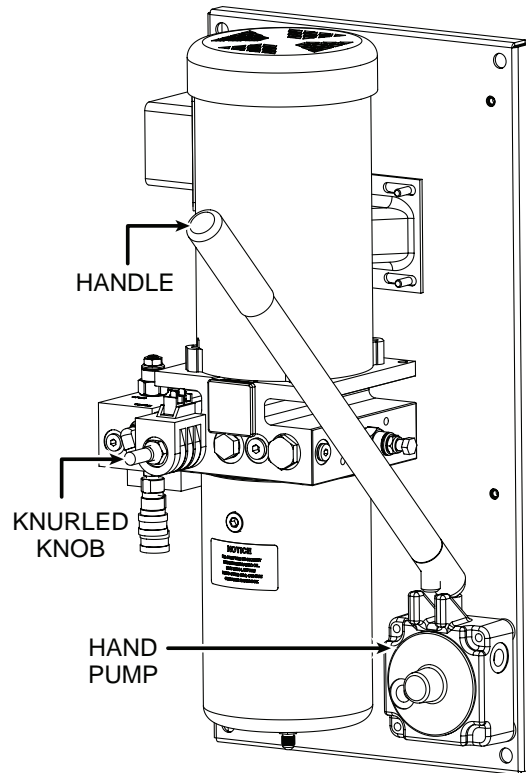

Figure 34. Hydraulic Hand Pump Open

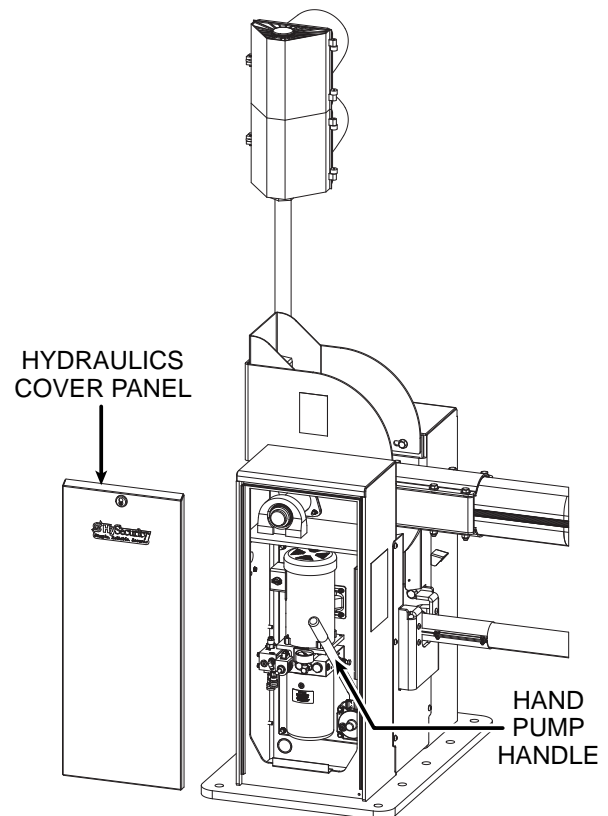

Figure 35. Hydraulic Hand Pump Open

SMART TOUCH ANALYZE AND RETRIEVE TOOL (S.T.A.R.T.)

HySecurity provides Smart Touch Analyze and Retrieve Tool (S.T.A.R.T.) software to help HySecurity gate operator users and installers conduct the following field service activities:

- Configure installer and user menu settings
- View the operator history (event) log
- Display monitored inputs for operator diagnostics
- Load Smart Touch Controller (STC) software

With S.T.A.R.T. software loaded on your laptop computer, you have an invaluable management tool for all HySecurity operators. The RS-232 serial port (found on the Smart Touch Controller), allows you to download system diagnostics and upload system configurations using the S.T.A.R.T. software. The free S.T.A.R.T. software is conveniently located at support.hysecurity.com. Instructions for downloading S.T.A.R.T. are on the website.

What You Need

HySecurity Serial RS-232 communication cable. Be sure to install the USB driver in your laptop, if you are using the HySecurity RS-232 to USB adapter.

- Laptop computer with Windows PC operating system (XP, Vista or 7)
- Minimum 128MB of RAM
- Minimum 5MB of hard drive disk space
- VGA graphics card (minimum resolution of 800 x 600)

Installing S.T.A.R.T. Software

Read the S.T.A.R.T. User Manual, and then take the following steps to download S.T.A.R.T. software:

1. Bring up your web browser and navigate to support.hysecurity.com.
2. Click the "Software" icon on the support page.
3. Click to Download: S.T.A.R.T. software for Smart Touch and Smart DC.
4. Read the End User License Agreement and, if you agree to the terms, click, "I accept" (bottom of the page).
5. Click RUN. A setup window appears.
6. Follow the step-by-step instructions to complete the installation.*
7. When the download is complete, exit the HySecurity support website. Shortcuts for the S.T.A.R.T. and STC History Logs appear on your laptop's desktop.

NOTICE

If the operating system on your laptop is VISTA or Windows 7, you must first disable the "In Windows 7" and then continue with step 7. See "Setting User Account Controls".

Setting User Account Controls

Because of the security settings inherent in VISTA and Windows 7, you need to disable the "user account controls" in the operating system before uploading S.T.A.R.T. software onto your laptop. Take the following steps:

In Windows 7

Go to S.T.A.R.T. Menu -> Control Panel -> User Accounts -> User Account -> Change User Account Control Settings"slide the slide bar to the lowest value (toward Never Notify), with description showing Never notify me ->Press Ok -> Reboot Computer.

In Windows 10:

Go to the S.T.A.R.T. Menu type "msconfig" and press Enter -> In System Configuration select the tools tab ->Scroll down till you find "Disable UAC" and single click it -> Press the Launch button -> Press the Apply button-> Press OK -> Reboot Computer.

ELECTRICAL CONTROLS

NOTICE

Before servicing, turn off all power switches.

No routine maintenance is needed for the electrical system or controls. If the environment is very sandy or dusty, or has many insects, be certain to seal all holes in the electrical enclosure. Blow the dust out of the electric panel with compressed air. Use "Table 7. Troubleshooting Codes" on page 72 to assess and fix error, alert, and fault codes. If it is necessary to call a distributor for assistance, be sure to have your model and serial number ready. Other helpful information includes the name of the job, approximate date of installation, and the service record of the operator, especially if any work has been done recently.

Clock Battery Replacement

A lithium coin battery supports the clock, so the date and time is retained even when the main power is turned off. Replace the battery about every five years (or as needed) with a DL 2025, DL 2032, or CR 2025, or CR 2032 battery.

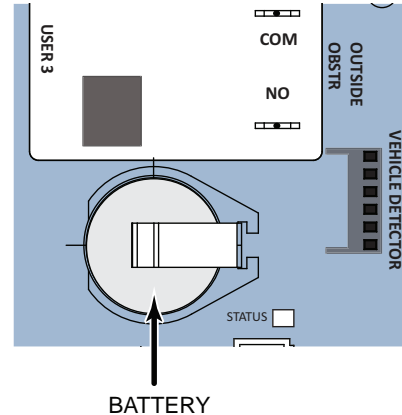

Figure 36. Battery Replacement Location

Fuse Replacement

A 2A fuse is located next to the power disconnect (I/O) switch on the Strong-Arm M30/M50 operator. It requires no maintenance, but if it were blown due to a power surge or other unusual circumstance, it must be replaced with a new fuse. The symptoms of a blown fuse appear as a control system malfunction (i.e. all control systems are inoperable). To troubleshoot a blown fuse, refer to "PROBLEM 4: All control systems are inoperable." on page 82.

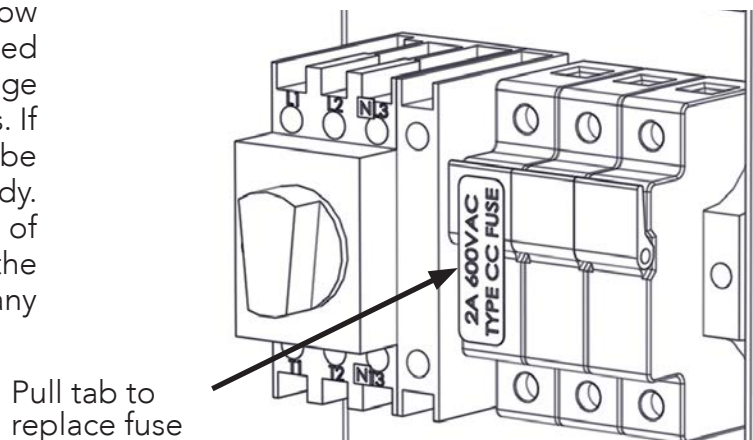

Figure 37. Fuse Replacement Location

MECHANICAL MAINTENANCE

NOTICE

Before checking the internal mechanisms of the operator, turn off all power switches.

The mechanical maintenance for the StrongArm M30/M50 is not in depth or difficult, but should be performed on a routine basis.

Schedule regular maintenance:

- ✓ Check for signs of rust. The operator chassis is zinc plated which is corrosion-resistant, but some environments may increase the rate of corrosion. If any areas of rust are found, reduce the spread of corrosion by treating the areas with a rust inhibitor.
- ✓ Grease the hydraulic cylinder Top Pin every 50,000 cycles. Use NLGI #2 Grade Moly EP lithium base grease only and apply it with a standard grease gun. Grease the other bearings (4 locations) and bottom cylinder pin every 100,000 cycles. Note that it is easiest to grease the Top Pin, when the Arm is in the up/open position. For more information, refer to "M30/M50 Hydraulic Cylinder Maintenance" on page 87.
- ✓ Replace worn-out batteries. Refer to "Clock Battery Replacement" on page 85.

HYDRAULIC SYSTEM MAINTENANCE

Fluid Level: Check fluid level with arm in down/closed position. Under normal conditions, hydraulic systems do not consume fluid. Check the system thoroughly for leaks, before adding any fluid. See Figure 38. If fluid needs to be added:

1. Remove the metal plug from the tank.
2. Use HySecurity Uniflow hydraulic fluid; part number MX000970. Gallon sold by our distributors.
3. Fill to within ½ inch of the plug level, and then replace plug.

NOTICE

Never use brake fluid. It will severely damage the hydraulic system. Use of any fluid other than fluid recommended by HySecurity may void the operator warranty.

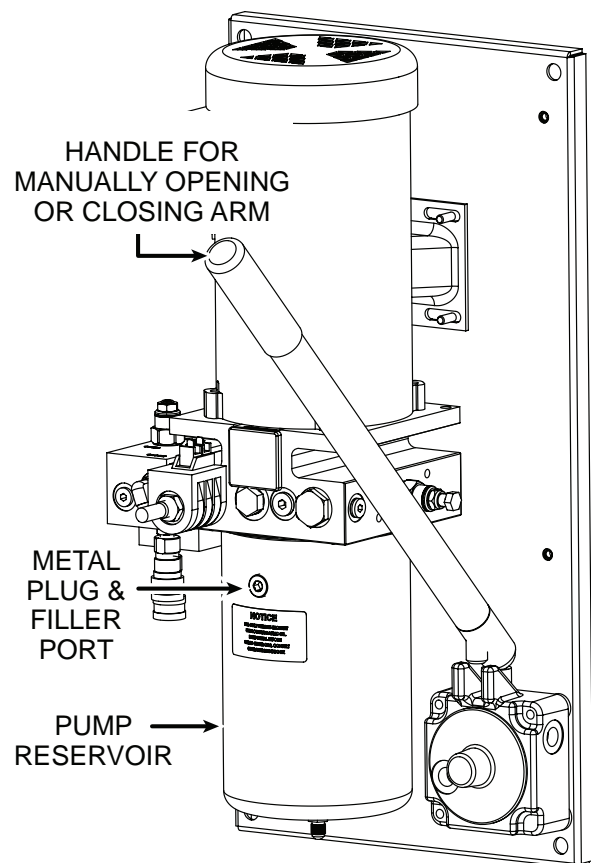

Figure 38. Hydraulic Pump

Look for leaks: Check tightness of fitting if leakage occurs. If leaking persists, replace “O” rings, fittings or hoses, if required. No further leaks should occur.

To Change Fluid: Unlike a gas engine, the fluid inside a hydraulic system does not foul, so fluid changes do not need to occur often. HySecurity recommends draining the reservoir and replacing the fluid at five-year intervals. Fluid breakdown caused by heat is the main concern. If the unit is subjected to high use, or you are using the HySecurity biodegradable fluid option (especially in a warm climate), change the fluid more frequently (250,000 cycle interval).

To change the hydraulic fluid,

1. Remove the reservoir from the pump pack.
2. Completely empty it.
3. Wipe the reservoir clean and clean the derby screen.
4. Re-assemble the pump unit and refill it with new Uniflow hydraulic fluid.
5. To avoid overfilling, slowly pour the fluid through the filler port near the reservoir’s top until the fluid is within ½ inch of the port’s opening.
6. Replace the plug and wipe up any spilled fluid. Spilled fluid dries to a sticky and messy consistency.

Cold Weather Issues:

1. Check that your reservoir is filled with our Uniflow high performance fluid.
2. Excessive ice buildup can partially or totally jam gate operation. Operate the gate manually, while clearing the ice buildup.
3. If the operator is located in an area of extreme snow conditions, regular maintenance to dig the operator out may be required. A heater option may help.

NOTICE

A biodegradable fluid option does exist, but it does not have the same fluid viscosity at extremely low temperatures. Uniflow fluid temperature rating is between -40°F and 158°F (-40°C and 70°C). The biodegradable fluid has a temperature rating between -10°F and 158°F (-23°C and 70°C).

M30/M50 Hydraulic Cylinder Maintenance

The hydraulic cylinder requires little maintenance other than applying NLGI #2 Grade Moly EP (Extreme Pressure) lithium base grease to the top and bottom pins (zerk fittings) at the intervals shown in the following table. See Figure 39.

Location on cylinder	M30/M50 Arm Cycles
Top Pin	50,000
Bottom Pin	100,000

NOTICE

To apply grease to the Top Pin, the Arm must be in the up/Open position.

WARNING

The contents of the hydraulic cylinder are under pressure. Close the Arm prior to making any brake adjustments or disassembly to the manifold at the base of the hydraulic cylinder. Failure to close the arm may result in personal injury.

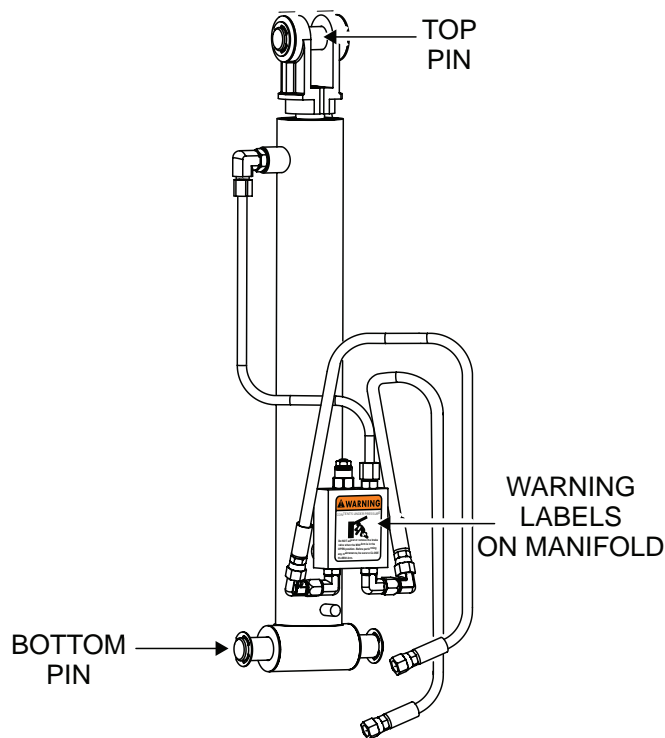

Figure 39. Hydraulic Cylinder Maintenance

M30/M50 Bearing Maintenance & Lubrication

Four bearing locations (Figure 40) also require lubrication according to the following table:

Bearing Location	M30/M50 Arm Cycles
Upper arm Pivot Pin (on both sides of the pivot post)	100,000
Lower arm Pivot Pin	100,000

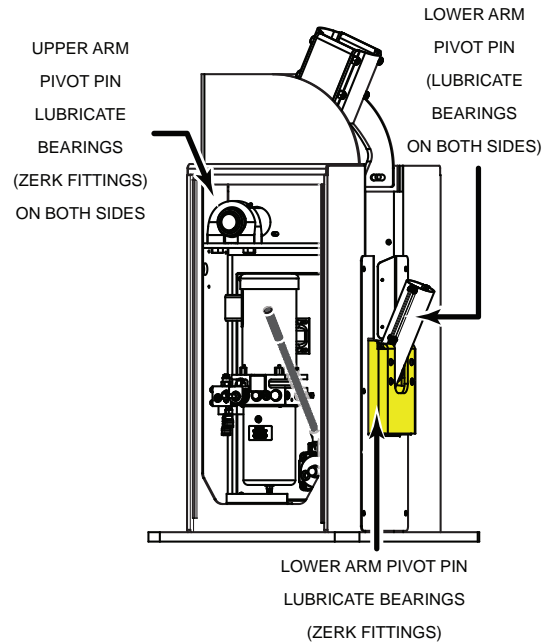

Figure 40. Hydraulic Pump Maintenance

MONTHLY VISUAL INSPECTIONS

Visual inspection shall be conducted to ensure there is no physical damage to the photo eye, traffic light, arm lights, buzzer, entrapment shield, or any other moving equipment.

WEEKLY TEST PROCEDURES

The photo eye, arm lights, traffic signal, and buzzer should be tested weekly for proper operation. To perform the tests, ensure power is turned on to the operator and the area around the arm is clear.

With the arm closed, verify arm lights are lit on both sides of arm (one row may or may not be flashing depending on User Menu setting) and red traffic light is on.

Press open button. Buzzer may or may not sound depending on User Menu setting. When arm stops in full open position, verify arm lights turn off and yellow traffic light is on.

Block photo eye, and press and release close button. Buzzer should chirp, indicating photo eye is preventing closure; arm should not close. Traffic light may briefly switch from red to yellow.

Uncover photo eye and press close button. Traffic light should turn red and arm lights turn on. Buzzer may or may not sound depending on User Menu setting. Arm should close fully and arm lights should be on, or flashing depending on User Menu setting.

This section provides illustrations that are useful to refer to during the prep and install phases.

- Appendix A:** Wiring Diagram D0437 and Hydraulic Schematic D0511
- Appendix B:** Wire Sizing and Runs
- Appendix C:** StrongArmM30/M50 Loop Design and Layouts
- Appendix D:** Installer's Checklist - An overview of the steps involved in installing the StrongArm Fortified Barrier Arm operator.

APPENDIX A - WIRING DIAGRAMS

STRONGARM M30/M50 WIRING DIAGRAM 220V CE M200 VFD, REV. B (1 OF 2)

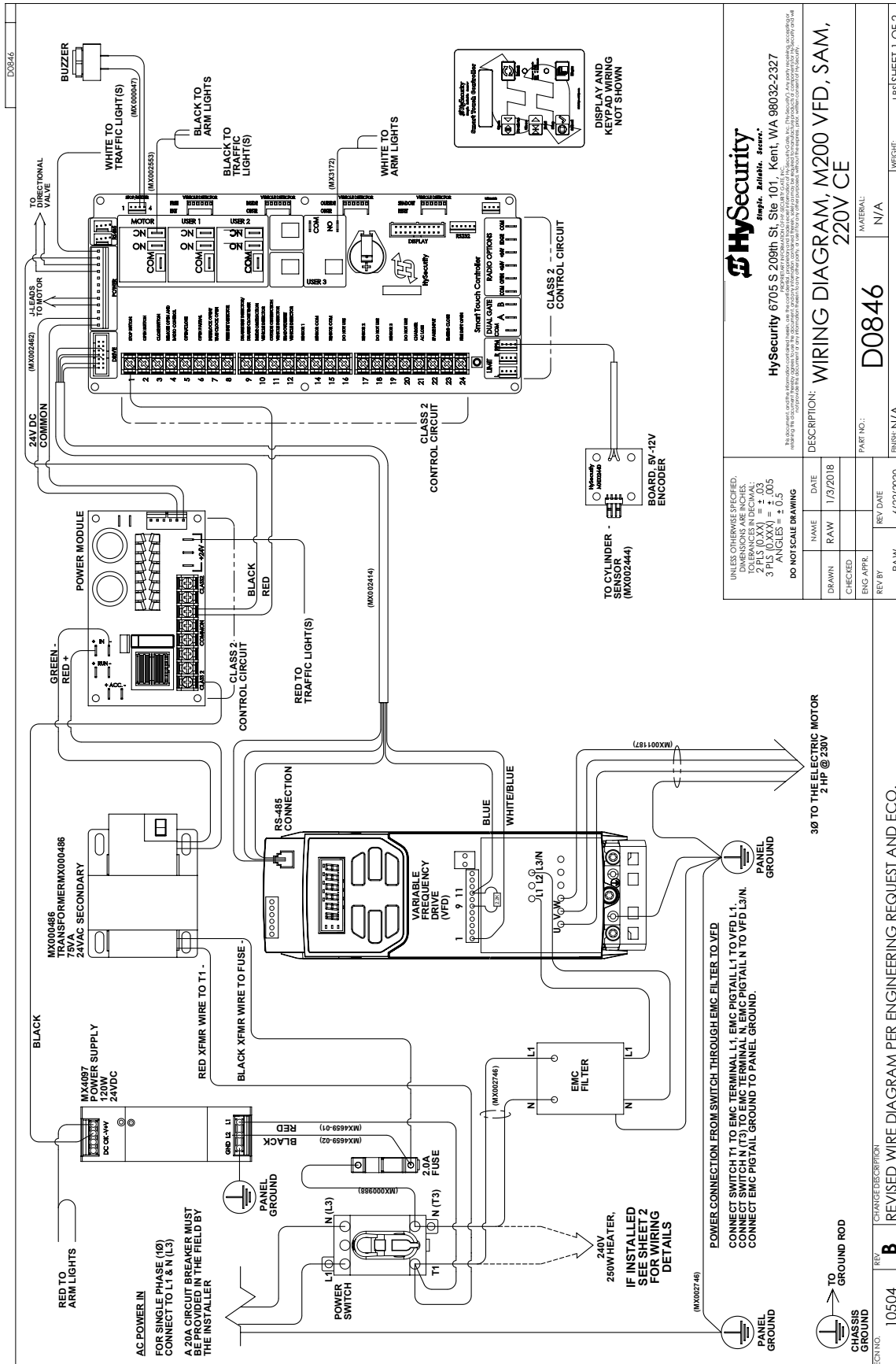

HySecurity
Simple. Reliable. Secure.
HySecurity 6705 S 209th St. Ste 101 Kent, WA 98032-2327

UNLESS OTHERWISE SPECIFIED, DIMENSIONS ARE IN INCHES.
TOLERANCES UNLESS OTHERWISE SPECIFIED:
2 PLS (0.XXX) = ± .03
3 PLS (0.XXX) = ± .005
ANGLES = ± 0.5

DO NOT SCALE DRAWING

NAME	DATE
DRAWN	RAW 1/3/2018
CHECKED	
ENG APPR.	
REV BY	RAW
REV DATE	6/22/2020

DESCRIPTION: WIRING DIAGRAM, M200 VFD, SAM, 220V CE

PART NO.: D0846 MATERIAL: N/A

FINISH: N/A WEIGHT: LBS | SHEET 1 OF 2

APPENDIX A - WIRING DIAGRAMS

STRONGARM M30/M50 WIRING DIAGRAM 220V CE M200 VFD, REV. B (2 OF 2)

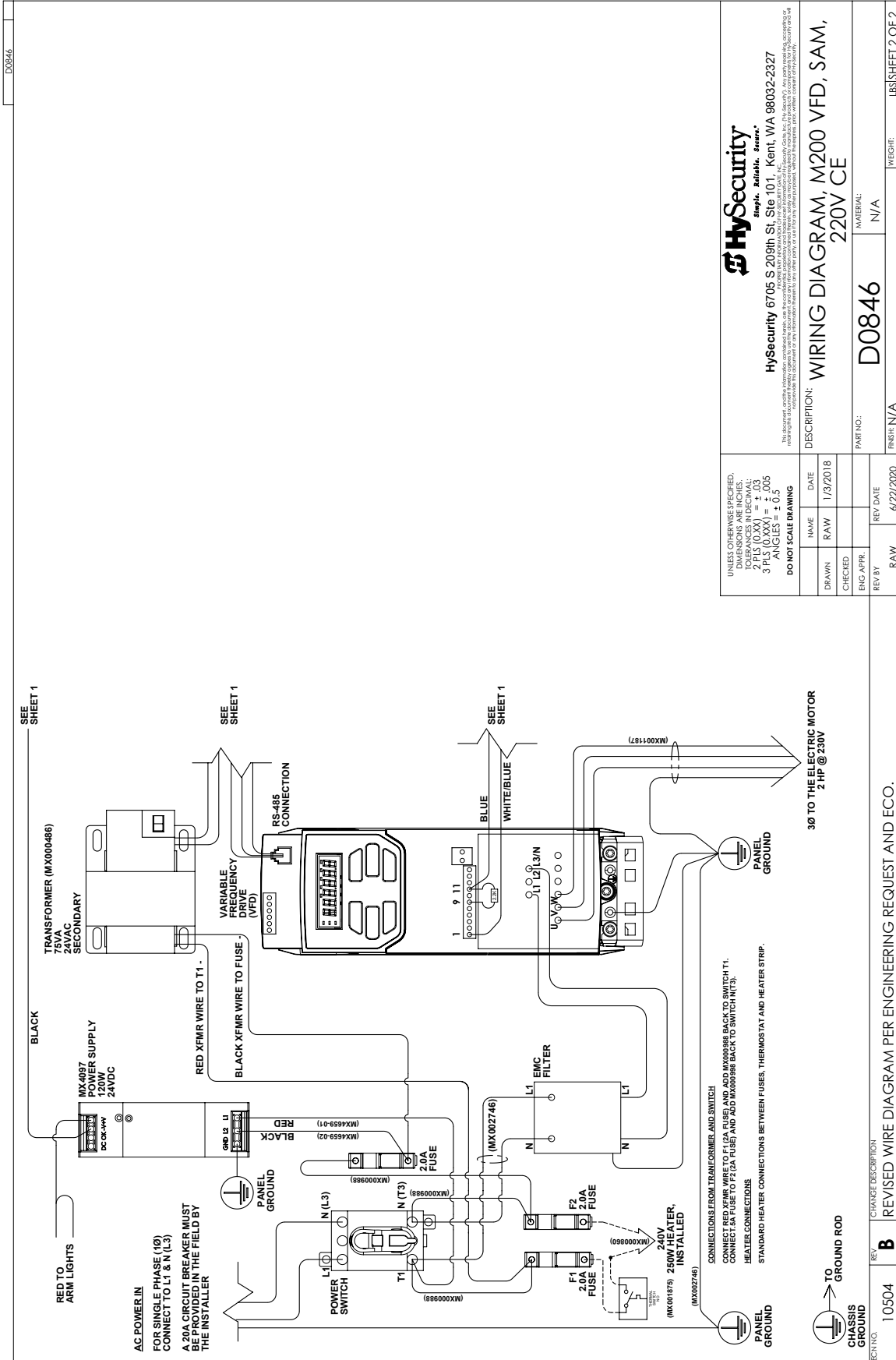

UNLESS OTHERWISE SPECIFIED, DIMENSIONS ARE IN INCHES. TOLERANCES ARE DECIMAL: 3 FLS (0.XXX) = ± 0.05 ANGLES = ± 0.5		 HySecurity Kingst, British Columbia HySecurity 6705 S. 209th St., Ste 101, Kent, WA 98032-2327 <small>HySecurity is a registered trademark of HySecurity Inc. All other trademarks are the property of their respective owners. HySecurity is not responsible for any damage to property or equipment caused by the use of this drawing. HySecurity is not responsible for any damage to property or equipment caused by the use of this drawing.</small>	
DO NOT SCALE DRAWING		DESCRIPTION: WIRING DIAGRAM, M200 VFD, SAM, 220V CE	
NAME	DATE	PART NO.	MATERIAL
RAW	1/3/2018	D0846	N/A
CHECKED			
ENG. APPR.			
REV BY	REV DATE	FINISH	WEIGHT
RAW	6/22/2020	N/A	LIBS SHEET 2 OF 2

APPENDIX A - WIRING DIAGRAMS

STRONGARM M30/M50 WIRING DIAGRAM 380V CE, REV. B (1 OF 2)

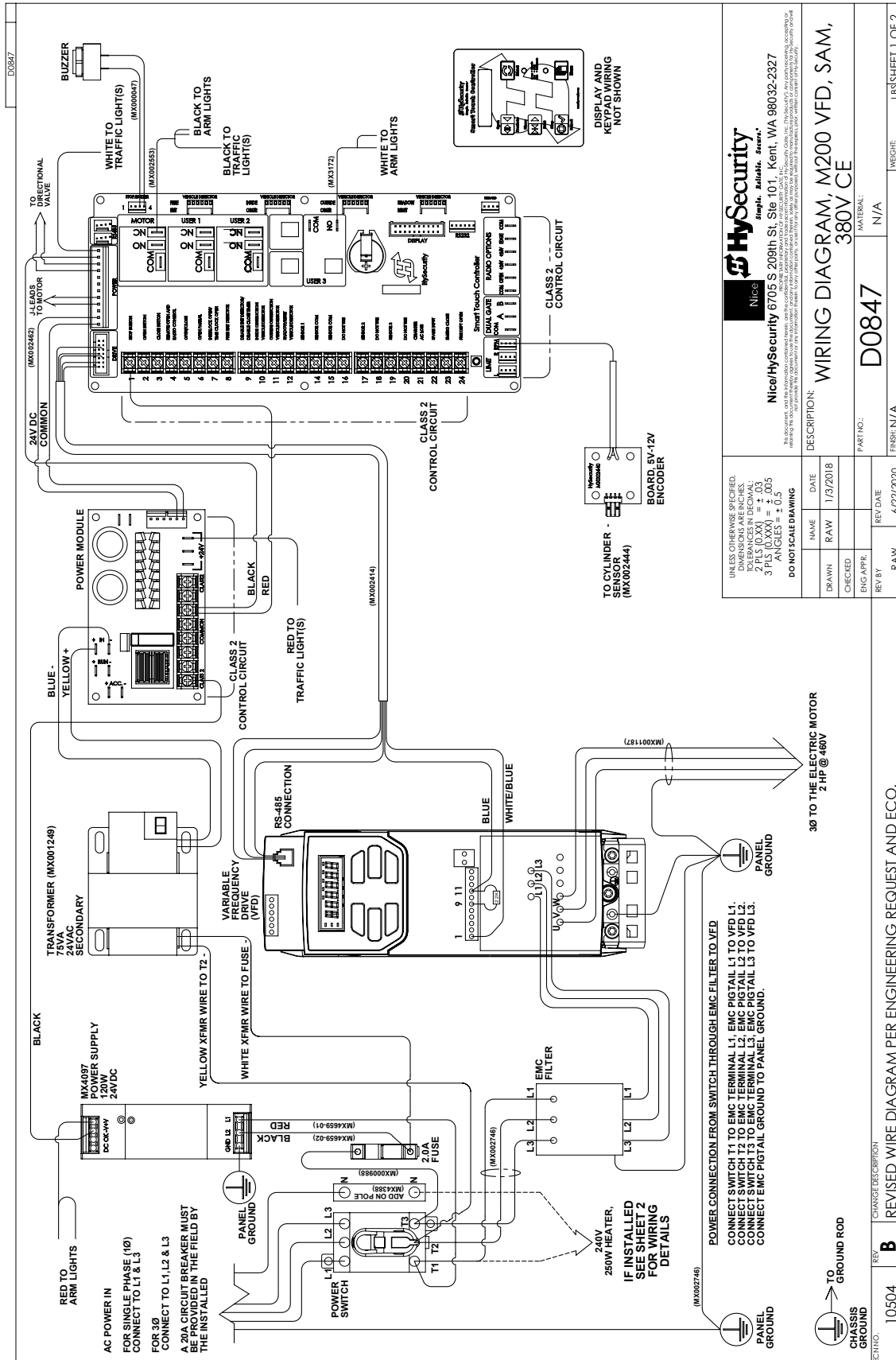

APPENDIX A - WIRING DIAGRAMS

STRONGARM M30/M50 WIRING DIAGRAM 380V CE, REV. B (2 OF 2)

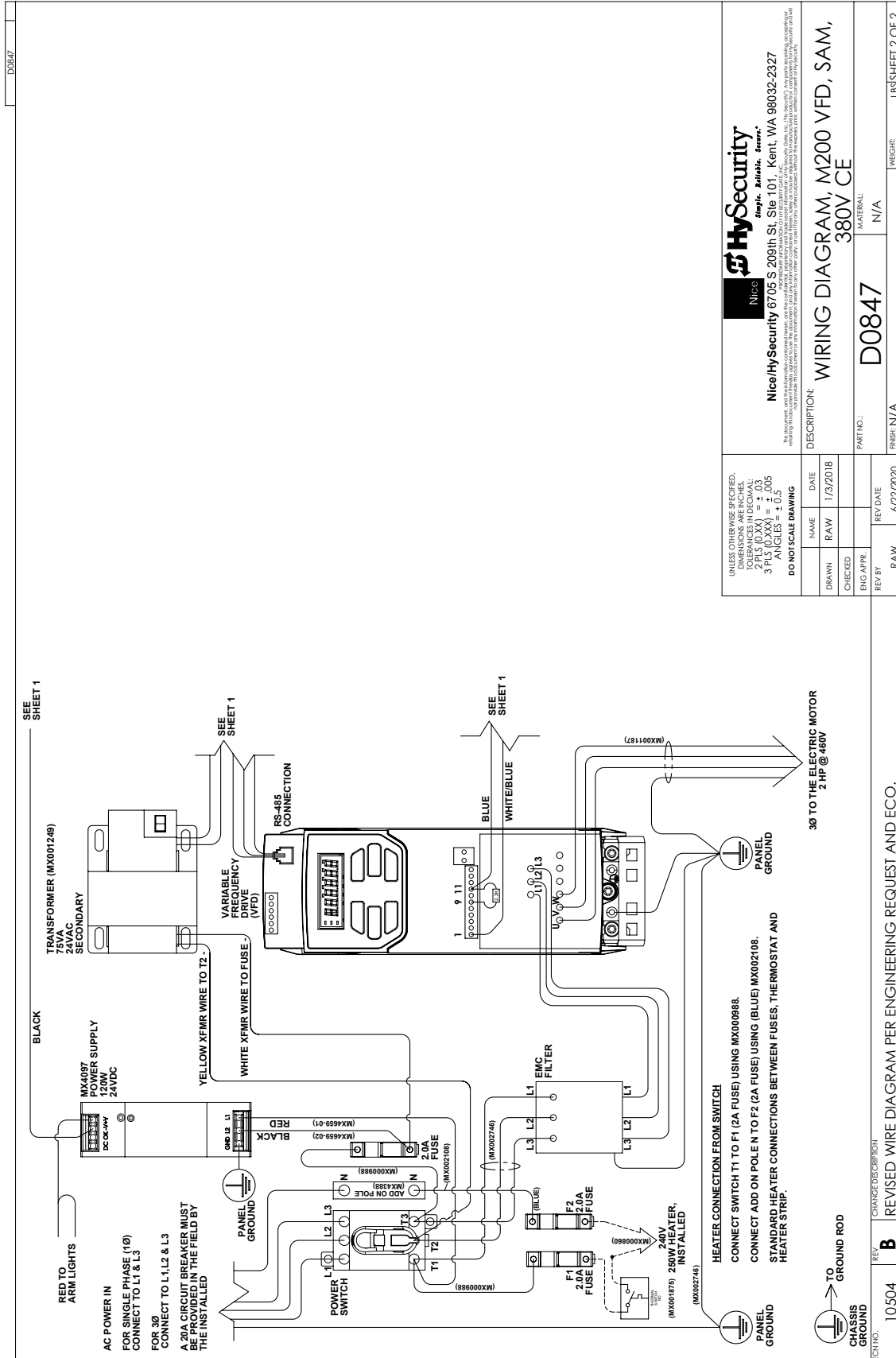

UNLESS OTHERWISE SPECIFIED, TOLERANCES IN DECIMAL: 2 PLS (XXX) = ± .03 3 PLS (XXX) = ± .05 4 PLS (XXX) = ± .05		 Nice HySecurity <i>Empire. Reliable. Secure.</i> Nice HySecurity 6705 S. 209th St. Ste 101, Kent, WA 98032-2327	
DO NOT SCALE DRAWING		DESCRIPTION:	WIRING DIAGRAM, M200 VFD, SAM, 380V CE
NAME	DATE	PART NO.:	MATERIAL:
DRAWN	RAW	6/22/2020	N/A
CHECKED	RAW		
ENG APPR	RAW		
REV BY	RAW		
REV DATE		REVISION	
6/22/2020		10504 B	
REV		CHASSIS DESCRIPTION	
10504 B		REVISED WIRE DIAGRAM PER ENGINEERING REQUEST AND ECO.	
ECON NO.		LBS SHEET 2 OF 2	

STRONGARM M30/M50 HYDRAULIC DIAGRAM

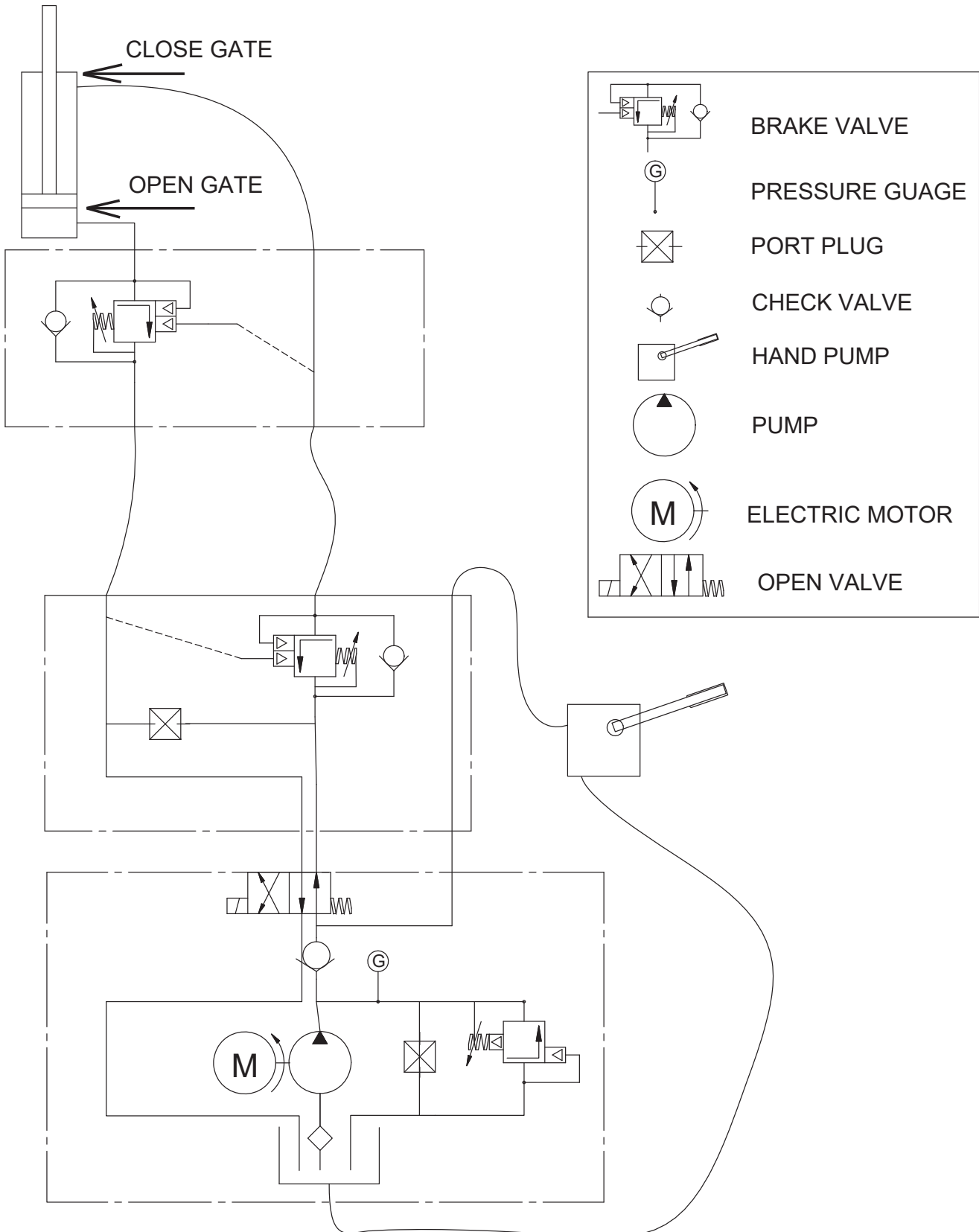

NOTE: DRAWING IS NOT TO SCALE.

WIRE SIZING AND RUNS

Supplying a StrongArm M30/M50 operator with the right electrical service is crucial to the performance of the operator and the life of its electrical components. If the wire size used is too small, the voltage loss, especially during motor startup, will prevent the motor from attaining its rated horsepower. The percentage of horsepower lost is far greater than the percentage of voltage loss. A voltage loss could also cause the control components to chatter while the motor is starting, substantially reducing their life due to the resultant arcing. There is no way to restore lost performance resulting from undersized wires, except to replace them. Be sure to choose a sufficient wire size at initial installation to avoid costly rewiring. See Wire Size Chart.

The tables on the following page are based on copper wire and allow for a 5% voltage drop. The ampere values shown are the service factor ampere rating (maximum full load at continuous duty) of the motor. A 20A circuit (protected with a 20A Inverse Time Breaker) should be provided, at minimum.

Always connect electrical power and ground the operator in accordance with the National Electrical Code, Article 430 and Article 250. Research and follow other local codes that may apply.

The maximum distance shown is from the operator to the power source; assuming that source power is from a panel box with adequate capacity to support the addition of this motor load. The values are for one operator, with no other loads applied to the branch circuit. Avoid placing more than one Arm operator to a circuit, but if you must, be certain to reduce the maximum allowed wire distance by half.

Low Voltage Control Wiring

The Smart Touch Controller has very sensitive control inputs. The following is a chart of maximum distances for wire size:

Wire Size	Maximum Distance
18 ga	7.0 miles (11km)
20 ga	3.5 miles (5.6km)
22 ga	2.7 miles (4.3km)
24 ga	2.0 miles (3.2km)
26 ga	1.0 mile (1.6km)
28 ga	3700 feet (1.1km)

APPENDIX B - WIRING SIZING & RUNS

StrongArm M30/M50 Wiring Chart (Incoming Power)

Make sure proper wiring is being used. The following table shows the maximum allowable wire run from the power source to the operator for various wire sizes:

Table 8. StrongArm M30/M50 Wire Size Chart						
Ø (Phase)	1	1	3	3	3	3
Voltage	208	230	208	230	380	460
Horsepower	2	2	2	2	2	2
Amps	17.4	17.4	8.7	8.7	5.2	5.2
Drop	11	12	11 3	12	19	23
Wire Gauge	Distance	Distance	Distance	Distance	Distance	Distance
14	60 (18m)	60ft (18m)	140 (43m)	150 (46m)	430 (131m)	520 (158m)
12	90 (27m)	100 (30m)	220 (67m)	240 (73m)	680 (207m)	830 (253m)
10	150 (46m)	170 (52m)	350 (107m)	390 (119m)	1090 (332m)	1310 (399m)
8	240 (73m)	270 (82m)	560 (171m)	620 (189m)	1730 (527m)	2100 (640m)
6	390 (119m)	430 (131m)	900 (274m)	990 (302m)	2750 (838m)	3330 (1015m)
4	620 (189m)	680 (207m)	1430 (436m)	1580 (482m)	4380 (1335m)	5300 (1615m)
2	990 (302m)	1090 (332m)	2280 (695m)	2530 (771m)	6990 (2130m)	8470 (2582m)
0	1560 (475m)	1730 (527m)	3620 (1103m)	4000 (1219m)	11,070 (3374m)	13,400 (4084m)

HOW A VEHICLE DETECTOR WORKS

An inductance field is created when the vehicle detector passes a small amount of alternating current through an in-ground, twisted wire, closed-loop system. A component of the vehicle detector measures the field's frequency. When a vehicle passes over an activated loop, the vehicle detector senses the resultant frequency drop in the inductance field and triggers the vehicle detector to output a command signal.

The effective height (H) of the loop's inductance field is two thirds (0.67) of the distance "X". To maintain a 4 foot (122 cm) inductance field height above ground level, the short side of the loop must be, at minimum, 6 feet (183 cm) in length. A minimum loop size consideration for detection of high bed vehicles is 6 x 8 feet (183 x 244 cm). See Figure 41.

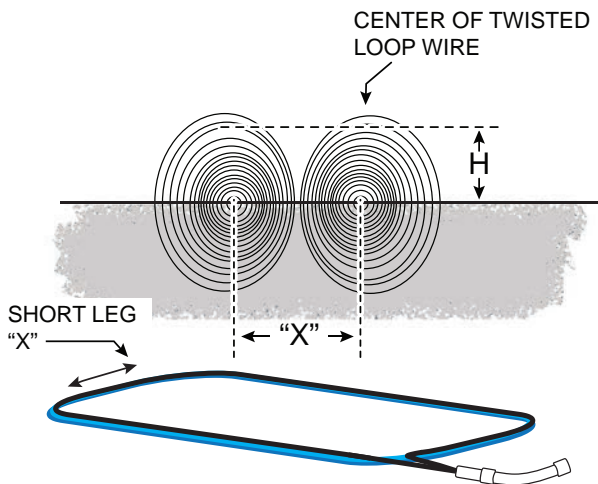

Multiply distance X by 0.67 (2/3) to determine effective height of vehicle loop. Inductance field created when loop is active. Twist in loop wire determines rotation of inductance field. Maximum loop size is 200 square feet.

Figure 41. Vehicle Loop Inductance Field

NOTICE

Any equipment (metallic object or item) that conducts electricity and is placed near the vehicle loop will change the frequency of the loop and affect the reading taken by the vehicle detector.

Site design considerations: See Figure 42 and Figure 43.

- Type of vehicular traffic using your site (high bed trucks, passenger vehicles, etc.)
- Proper size and number of vehicle loops (For general passenger vehicle detection, minimum loop size should be 6 x 6 foot (183 x 183 cm.) For truck traffic, minimum loop size is 6 x 8 foot (183 x 244 cm))
- Distance between threshold of gate opening and in-ground loop wire is a minimum of 4 foot (122 cm) (The exception to this rule is a Reset Loop used in barrier arm gates. Refer to Loop Layout Diagrams)
- Conduit that runs parallel to a loop must have, at minimum, 1 foot (31 cm) of clearance

CAUTION

Vehicle detector loops that are sized too small may not sense high bed trucks and, inadvertently, send an "all clear" signal to close the gate which could cause damage to vehicles or injury to personnel.

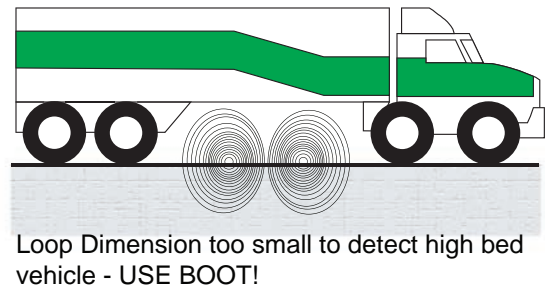

Figure 42. Small Detector Loops

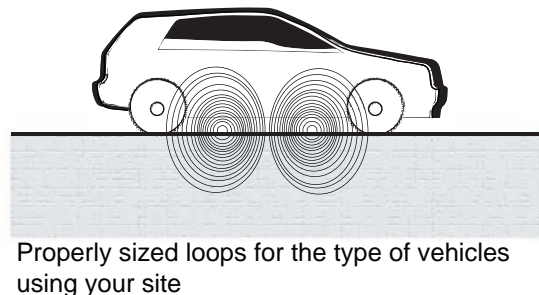

Figure 43. Proper Detector Loops

APPENDIX C - VEHICLE LOOP LAYOUT

It is important to locate and measure the vehicle detection loops according to the following dimensions:

- ◆ The Reset Loop must be centered under the barrier arm
- ◆ A = 6 to 18 ft (183 to 549 cm)
- ◆ B* = 6 to 8 ft (183 to 244 cm)
- ◆ C = Maintain 3 ft (91 cm) between the loop and edge of roadway
- ◆ D* = 1 to 5 ft (30 to 152 cm). Vehicle must move from one loop to the next without loss of detection
- ◆ E = 10 to 12 f (305 cm to 366 cm) if an access control device i s employed
- ◆ F = 2 ft minimum clearance (61 cm)

Several Sequenced and Interlocked loop layout scenarios are provided in this section. For more information, refer to "Connecting an Interlocked Pair (Dual Gate)" on page 65.

APPENDIX C - VEHICLE LOOP LAYOUT

SEQUENCED GATES #1 - SLIDE GATE LOOP LAYOUT

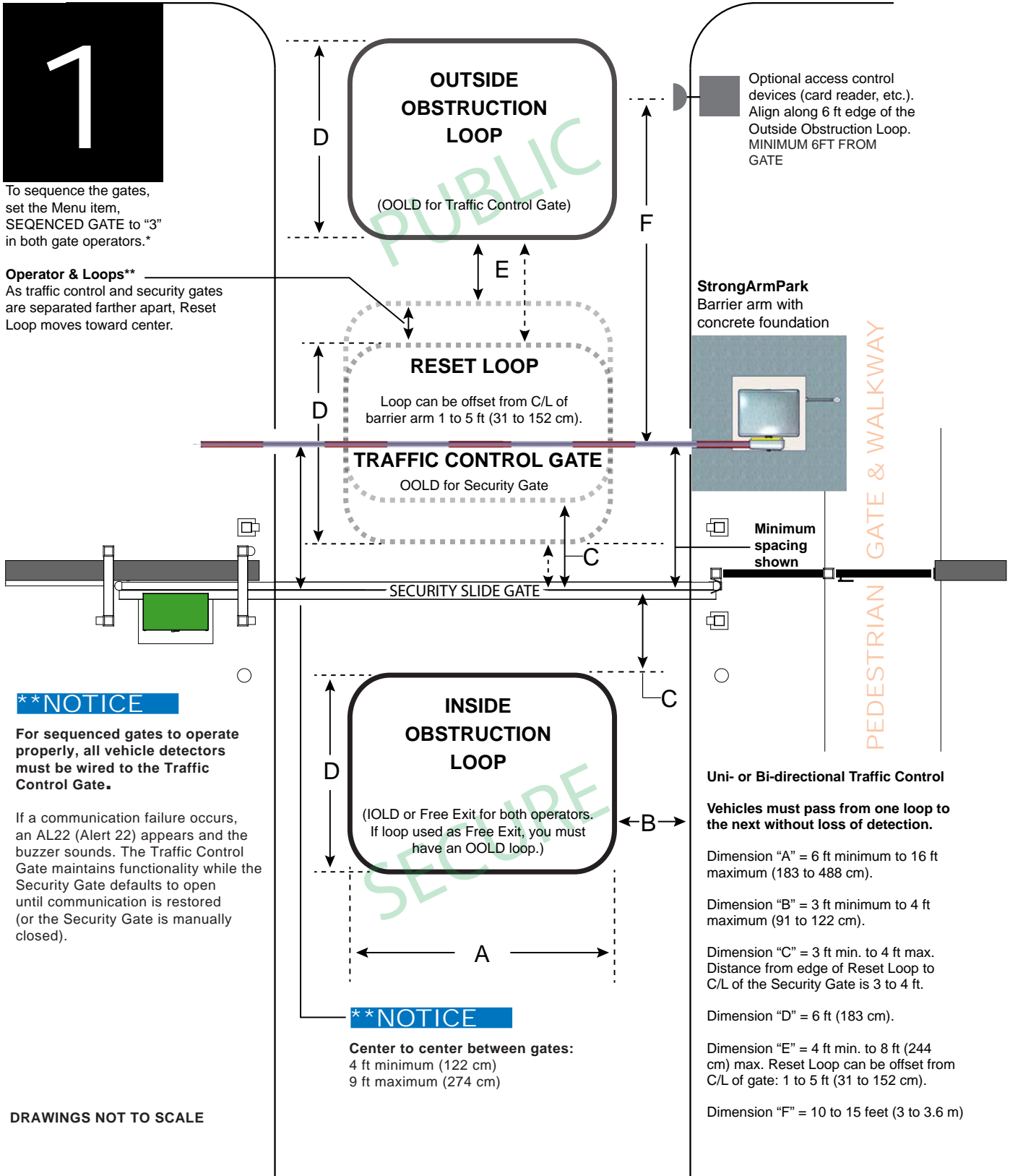

DRAWINGS NOT TO SCALE

APPENDIX C - VEHICLE LOOP LAYOUT

SEQUENCED GATES #2 - SLIDE GATE LOOP LAYOUT

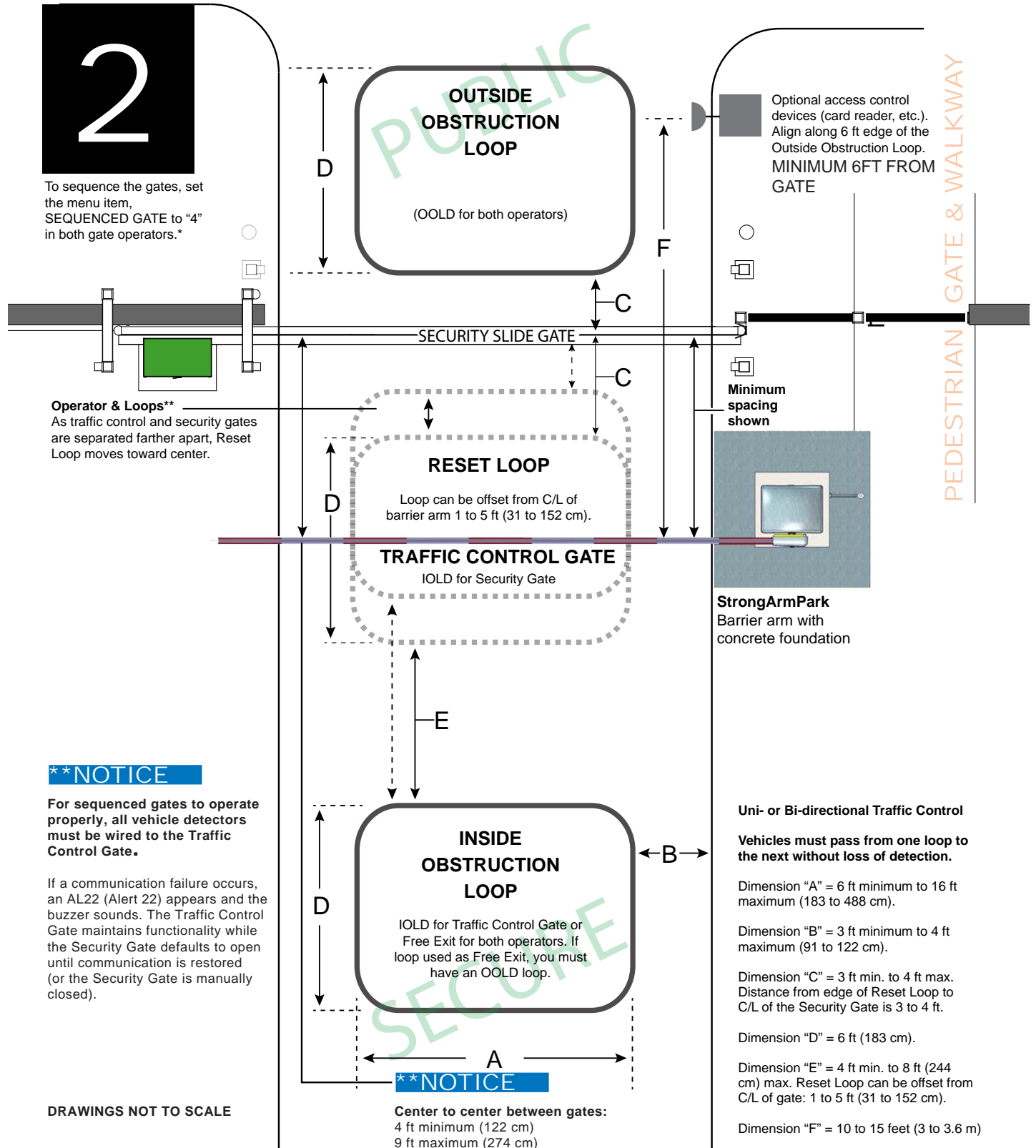

APPENDIX C - VEHICLE LOOP LAYOUT

SEQUENCED GATES #1 - SWING GATE LOOP LAYOUT

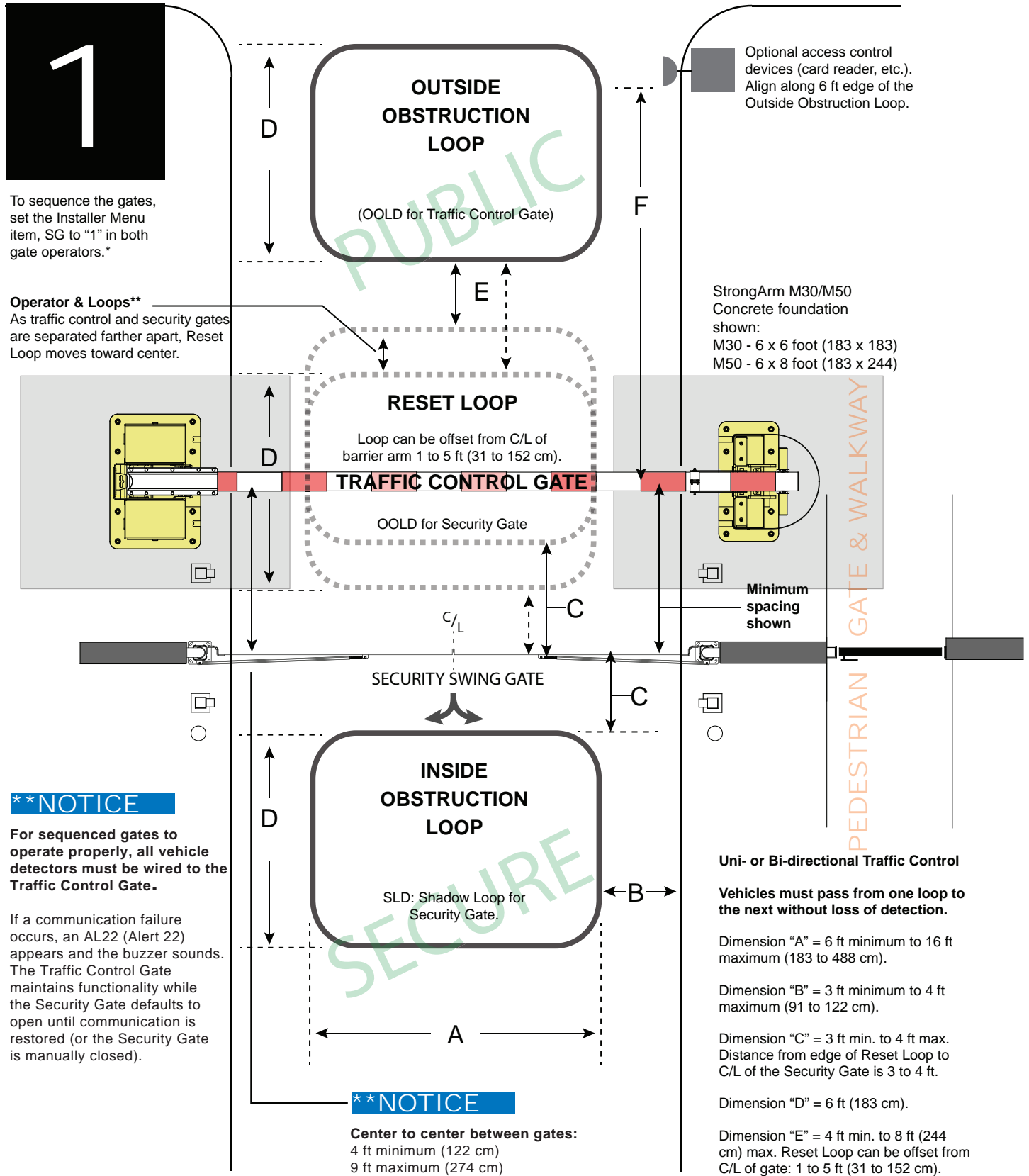

APPENDIX C - VEHICLE LOOP LAYOUT

SEQUENCED GATES #2 - SWING GATE LOOP LAYOUT

2

To sequence the gates, set the Installer Menu item, SG to "1" in both gate operators.*

Operator & Loops**

As traffic control and security gates are separated farther apart, Reset Loop moves toward center.

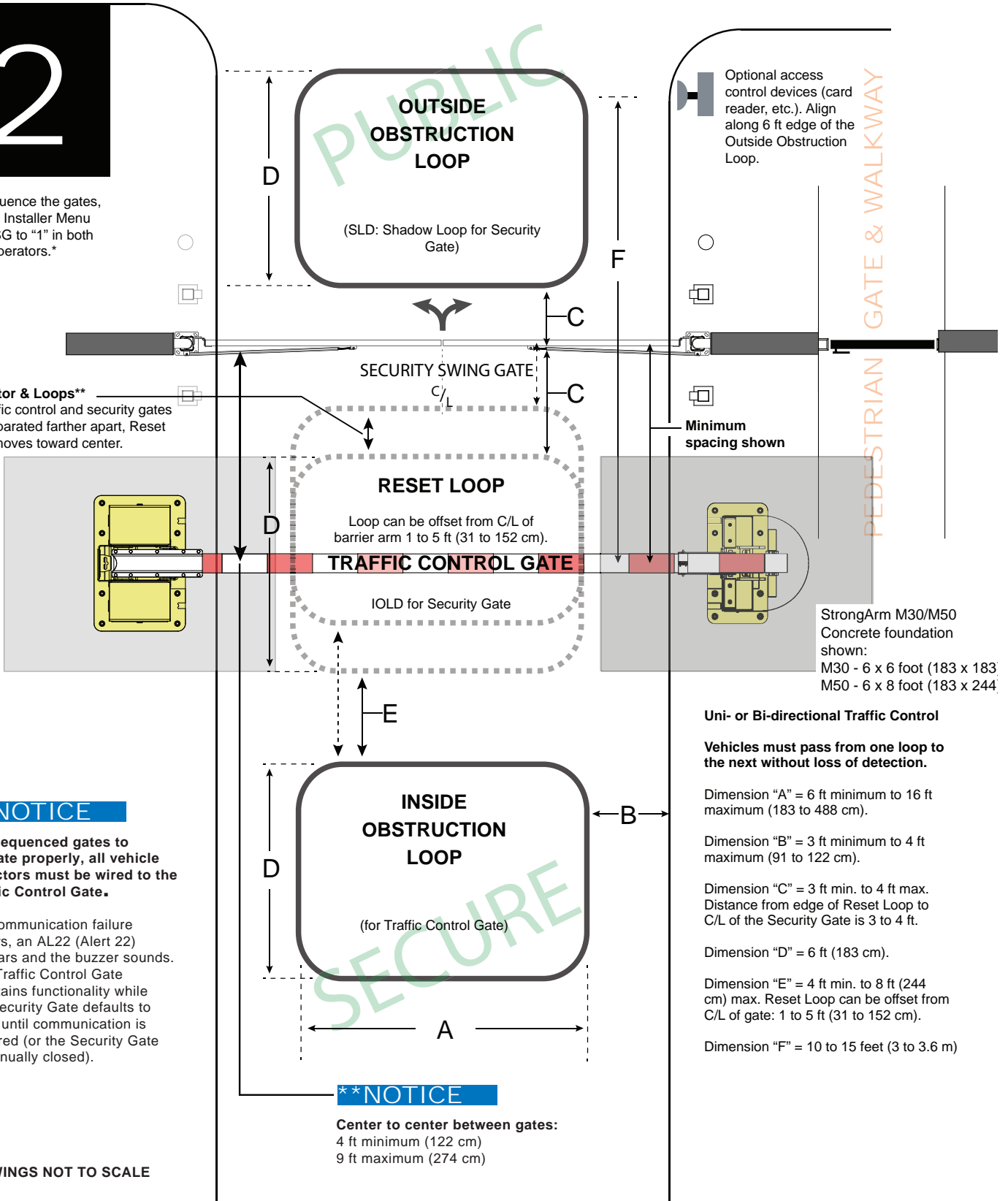

Optional access control devices (card reader, etc.). Align along 6 ft edge of the Outside Obstruction Loop.

Minimum spacing shown

StrongArm M30/M50 Concrete foundation shown:
M30 - 6 x 6 foot (183 x 183)
M50 - 6 x 8 foot (183 x 244)

Uni- or Bi-directional Traffic Control

Vehicles must pass from one loop to the next without loss of detection.

Dimension "A" = 6 ft minimum to 16 ft maximum (183 to 488 cm).

Dimension "B" = 3 ft minimum to 4 ft maximum (91 to 122 cm).

Dimension "C" = 3 ft min. to 4 ft max. Distance from edge of Reset Loop to C/L of the Security Gate is 3 to 4 ft.

Dimension "D" = 6 ft (183 cm).

Dimension "E" = 4 ft min. to 8 ft (244 cm) max. Reset Loop can be offset from C/L of gate: 1 to 5 ft (31 to 152 cm).

Dimension "F" = 10 to 15 feet (3 to 3.6 m)

** NOTICE

For sequenced gates to operate properly, all vehicle detectors must be wired to the Traffic Control Gate.

If a communication failure occurs, an AL22 (Alert 22) appears and the buzzer sounds. The Traffic Control Gate maintains functionality while the Security Gate defaults to open until communication is restored (or the Security Gate is manually closed).

** NOTICE

Center to center between gates:
4 ft minimum (122 cm)
9 ft maximum (274 cm)

DRAWINGS NOT TO SCALE

CHECKLIST - POST INSTALLATION

StrongArm^(R) M30/M50 Post Installation Checklist

Date Installed: _____
 Site Location: _____
 Customer Name: _____
 Mailing Address: _____

 Phone Contact: _____

StrongArmM30/M50 Arm Length: _____
 Serial Number: _____
 Inspected by: _____
 Date Inspected: _____

1. Foundation

1.1 Concrete Foundation to Spec

Concrete foundation with rebar mats poured to specifications.

Concrete foundation measurement: _____

Integrity of the concrete intact (no cracks). Proper drainage around Pivot & Catch Posts with no pooling water visible.

Checked Initials _____

2. Pivot & Catch Posts Alignment

2.1 Clear Opening

Measure and verify the clear opening: _____

2.2 Pivot & Catch Posts centered & plumb & secure

Posts are centered on concrete and plumb (measure from center line).

Ten washers and nuts properly attached to the anchor bolts and torque wrenched to 200ft-lb.

2.3 Upper & Lower Catch Pin

A 3/4 inch gap exists between the catch pins and posts. See diagrams.

2.4 Clearance between Pivot post and adjacent wall

A minimum clearance exists between the electrical cabinet and the pivot post. See diagrams.

Checked Initials _____
 Initials _____
 Initials _____
 Initials _____

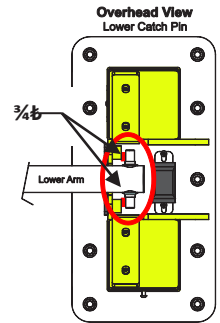

3. Safety

3.1 Check for the following:

- Separate pedestrian entry gate and walkway.
- Entrapment shield installed properly.
- Warning labels apparent and affixed to the M30/M50 Arm.

Checked Initials _____

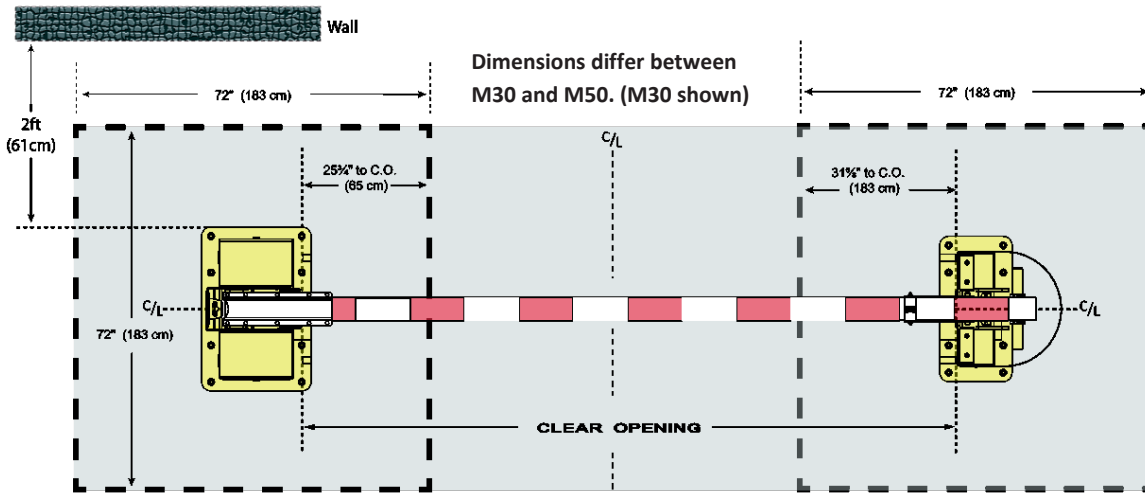
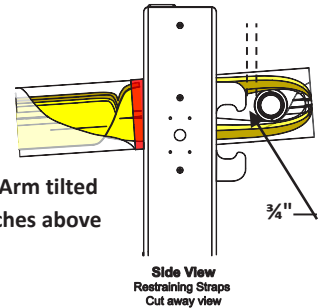

StrongArm^(R) M30/M50 Post Installation Checklist

4. Electrical

Checked

Initials

4.1 Measure Input Voltage

Single Phase: (check all boxes that apply)

- 208V 230V 50Hz 60Hz 20A

Three Phase: (check all boxes that apply)

- 208V 230V 380V 480V
- 50Hz 60Hz 15A 20A

4.2 Input Power Connections

Input power properly connected to Directional Power Switch

- Single Phase: L1 & L3 Three Phase: L1, L2 & L3

VFD properly connected to Directional Power Switch

- Single Phase: T1 & T3 Three Phase: T1, T2 & T3

4.3 Grounding

- Solid copper ground rod: (3/8-inch diameter, 10ft length) driven into ground within 3ft of operator.
- Single length of unspliced 6AWG copper wire less than 3ft long attached to lug nut on chassis.

4.4 Upper Arm LEDs

- Plugged into the STC board and functioning properly.
- Cables fed properly through strain relief holes in saddle. Cables are not being chafed.

4.5 Traffic Light

Always red until M30/M50 Arm fully open, and then turns yellow.
Cable connections: Black to Black, Red to Red, White to White

5. Accessories

5.1 Proper installation and operation

- Operator push button. Keypad, Additional photo eye working properly.
- Other: _____

6. Detection Loops

6.1 Three loops recommended (OOLD, RESET, IOLD)

Outside Obstruction Loop, Reset Loop, & Inside Obstruction Loop are well laid and within specifications. (Refer to diagrams shown in the product manual.)

Test vehicle detection and check which type of vehicle detectors are used. Note it here:

- HySecurity HY5B Other: _____

7. Mechanical & End User Demonstration

7.1 Check the operator for the following:

- Hand pump operational and working properly.
- Vent plug on pump pack removed and replaced with breather cap.
- M30/M50 Arm cycled several times. Check for smooth operation of M30/M50 Arm; 90+ degrees vertical; horizontal– no sags.
- Limits set properly; Bumper pad compression on open no more than 1/4-inch. Warn before buzzer operational.
- Integrated photo eye stops arm movement when triggered in close direction.

8. Photographs & Checklist Submittal

Photos taken of the Arm open & closed, Pivot & Catch posts, and foundation.

Photograph the Pivot chassis (both sides) with the covers off and on.

Photos show the entire gate installation from the secure and public side. Photographs stored securely for future reference.

1. Warranty.

HySecurity Gate, Inc. ("HySecurity") warrants that at the time of sale each HySecurity-branded product that it sells will, in all material respects, conform to its then applicable specification and will be free from defects in material and manufacture.

The following additional durational warranties apply to HySecurity products, depending on whether (1) the product is purchased through an authorized HySecurity distributor and (2) whether a timely and complete product registration is submitted to HySecurity.

It is therefore important that you register your product with HySecurity, online at www.hysecurity.com/warranty, within the 60-day period described below.

1(a) HySecurity Products Purchased Through Authorized Distributors and Properly Registered

For any gate operator product that is purchased from an authorized HySecurity distributor (this excludes product purchased through internet resellers or any distributor not authorized by HySecurity), if the product registration is completed by the Dealer/Installer or End User within 60 days of the date of purchase, the following warranty terms will apply. HySecurity warrants that the product will remain serviceable for the following periods:

- a) Hydraulic industrial gate operator hydraulics, controls, and mechanical components: Five Years or 500,000 gate cycles (whichever occurs first) after the date of installation,
- b) Hydraulic wedge operator hydraulics and controls: Five Years or 500,000 cycles (whichever occurs first) after the date of installation. Wedge mechanical components: Two Years after the date of installation,
- c) Electromechanical pad-mounted Slide and Swing operators: Five Years or 500,000 cycles (whichever occurs first) after the date of installation, except single family residential usage, where the warranty term shall be Seven Years after the date the product was shipped from HySecurity,
- d) Electromechanical linear actuator Swing operators: Two Years after the date of installation,
- e) Electromechanical surface mount wedge operator electronics: Two Years or 500,000 gate cycles (whichever occurs first), after the date of installation,
- f) Electromechanical Barrier Arm Operators: Two years or 1,000,000 gate cycles (whichever occurs first) after the date of installation,

provided that the preceding Five Year warranty period in (a), (b), and (c) will not extend beyond seven years from the date that the product was shipped from HySecurity, and the Two Year warranty period in (b), (d), (e), and (f) will not extend beyond four years from the date that the product was shipped from HySecurity.

The preceding warranty durations do not apply to the products or components described below (g-j), which have a shorter warranty period:

- g) Hydraulic gate operator drive wheels, including XtremeDrive™ wheels and rack: Two Years from date of installation.
- h) AC and DC power supplies, chargers, and inverters and HyNet™ Gateway: Two Years from date of installation, except batteries.
- i) Batteries: One Year from date of shipment from HySecurity.
- j) Components subject to normal wear including, but not limited to, chains, belts, idler wheels, sprockets and fuses: One Year from date of installation.

1(b) HySecurity Products Not Purchased Through an Authorized Distributor or Not Properly Registered within 60 Days

For any product that is not purchased from an authorized HySecurity distributor or for which the product registration was not completed by the Dealer/Installer/End User within sixty (60) days of the date of purchase, the following warranty will apply: HySecurity warrants that the product will remain serviceable for the following periods, which begin on the date that the product was shipped from HySecurity:

- a) All gate operators: One Year or 100,000 gate cycles, whichever comes first.
- b) AC and DC power supplies, chargers, or inverters: One Year.
- c) HyNet™ Gateway: One Year.
- d) Hydraulic gate operator drive wheels: One Year.

1(c) Replacement Parts

HySecurity warrants that replacement parts (whether new or reconditioned) will remain serviceable for One Year from the date that the part was shipped from HySecurity or the remaining period of the Gate Operator warranty, whichever is longer.

1(d) Limitations and Exclusions Applicable to Each of the Preceding Warranties.

The preceding warranties shall not apply to equipment that has been (1) installed, maintained, or used improperly or contrary to instructions; (2) subjected to negligence, accident, vandalism, or damaged by severe weather, wind, flood, fire,

terrorism or war; or (3) damaged through improper operation, maintenance, storage or abnormal or extraordinary use or abuse. Any modification made to products will void the warranty unless the modifications are approved in writing by HySecurity in advance of the change (this exclusion does not apply to normal installation of approved accessories and/or protective devices or sensors). It is the responsibility of the Distributor, Dealer/Installer, or End User to ensure that the software version in the product is maintained to the latest revision level.

The preceding warranties do not extend to accessories when those items carry another manufacturer's name plate and they are not a part of the base model. HySecurity disclaims all warranties for such accessory components, which carry only the original warranty, if any, of their original manufacturer. HySecurity hereby assigns its rights under such manufacturer warranties—to the extent that such rights are assignable—to Buyer.

These warranties extend to HySecurity's Distributors, to the Dealer/Installer, and to the first End User of the product following installation. They do not extend to subsequent purchasers.

2. Exclusion of Other Warranties.

The warranties contained in Section 1 are the exclusive warranties given by HySecurity and supersede any prior, contrary or additional representations, whether oral or written. Any prior or extrinsic representations or agreements are discharged or nullified. HYSECURITY HEREBY DISCLAIMS AND EXCLUDES ALL OTHER WARRANTIES—WHETHER EXPRESS, IMPLIED, OR STATUTORY—INCLUDING ANY WARRANTY OF MERCHANTABILITY, ANY WARRANTY OF FITNESS FOR A PARTICULAR PURPOSE, ANY LIABILITY FOR INFRINGEMENT, AND ANY WARRANTIES OTHERWISE ARISING FROM COURSE OF DEALING, COURSE OF PERFORMANCE, OR USAGE OF TRADE.

3. Buyer's Exclusive Remedies for Any Nonconformity.

If a HySecurity product fails to conform to the warranties in Section 1, Buyer must notify and order replacement parts from the Distributor through which the product was purchased within a reasonable time and in no event more than thirty (30) days after the discovery of the nonconformity. HySecurity will investigate and, in the event of a breach, will provide, within a reasonable period of time, one of the following: (1) repair or replacement of any nonconforming products or components or (2) refund of the price upon return of the nonconforming items. HySecurity reserves the right to supply used or reconditioned material for all warranty claims. HySecurity will not be considered to be in breach of or default under this Warranty because of any failure to perform due to conditions beyond its reasonable control, including any force majeure. This warranty does not cover any incidental expenses, including fines or penalties, temporary security, labor, shipping, travel time or standby time that are incurred for inspection or replacement of any nonconforming items. As a condition of warranty coverage, warranty claims must be submitted in accordance with the procedures described on the HySecurity form, "RMA Procedures."

THE REMEDY SELECTED BY HYSECURITY IN ACCORDANCE WITH THIS PARAGRAPH SHALL BE THE EXCLUSIVE AND SOLE REMEDY OF BUYER FOR ANY BREACH OF WARRANTY.

4. Exclusion of Consequential and Incidental Damages.

HYSECURITY SHALL NOT BE LIABLE FOR ANY INCIDENTAL, SPECIAL, OR CONSEQUENTIAL DAMAGES, WHETHER RESULTING FROM NONDELIVERY OR FROM THE USE, MISUSE, OR INABILITY TO USE THE PRODUCT OR FROM DEFECTS IN THE PRODUCT OR FROM HYSECURITY'S OWN NEGLIGENCE. This exclusion applies regardless of whether such damages are sought for breach of warranty, breach of contract, negligence, or strict liability. This exclusion does not apply to claims for bodily injury or death.

5. Severability.

If any provision of this warranty is found to be invalid or unenforceable, then the remainder shall have full force and effect.

6. Proprietary Rights.

HySecurity retains and reserves all right, title, and interest in the intellectual property rights of its products, including any accompanying proprietary software. No ownership of any intellectual property rights in the products or accompanying software is transferred to Distributor, Dealer/Installer, or End User.

7. Applicable Law.

This warranty will be interpreted, construed, and enforced in all respects in accordance with the laws of the State of Washington, without reference to its choice of law principles. The U.N. Convention on Contracts for the International Sale of Goods will not apply to this warranty.

StrongArm® M30/M50 models

Model	StrongArm M30	StrongArm M50	StrongArm M30 NP	StrongArm M50 NP
Crash Certified	ASTM F2656-07 M30-P1*	ASTM F2656-07 M50-P2*	ASTM F2656-07 M30-P1*	ASTM F2656-07 M50-P2*
Duty Cycle	100 cycles/hr**, option for continuous duty		Manually operated	Manually operated
Horsepower	2 hp		—	
Drive	Hydraulic		—	
Open/Close Time	6 to 8 seconds depending on arm length		Open time: approx. 1 to 3 minutes depending on arm length Close time: approx. 15 to 25 seconds depending on arm length	
Emergency Fast Operate Time	5 to 7 seconds depending on arm length		—	
Clear Opening	12 to 24 ft in 2 ft increments (366 to 732 cm in 61 cm increments) Call for custom arm length		12 to 24 ft in 2 ft increments (366 to 732 cm in 61 cm increments) Call for custom arm length	
Full Open Angle	90°		Adjustable 88° ± 2°	
Ingress Protection	IP56		IP56	
Temperature Rating	-40° to 158° F (-40° to 70° C) or -10° to 158° F (-23° to 70° C) using biodegradable fluid		40° to 158° F (-40° to 70° C) or -10° to 158° F (-23° to 70° C) using biodegradable fluid	
1 Phase Power	208/230V, 60/50 Hz 20A		—	
3 Phase Power	208/230V, 60/50 Hz, 380/460V, 60/50 Hz		—	
Communication	RS-232, RS-485, Ethernet/fiber using optional HyNet™ Gateway accessory		—	
User Controls	Smart Touch Controller with 70+ configurable settings, programmed via the keypad and display or a PC using S.T.A.R.T. software.		—	
Relays	Three configurable user relays: one 30VDC, 3A solid state and two 250VAC, 10A electromechanical; Optional Hy8Relay™ for 8 additional relay outputs		—	
Finish	Hot dipped galvanized standard. Optional textured yellow powder coat over zinc plating.		Hot dipped galvanized standard. Optional textured yellow powder coat over zinc plating.	
Foundation	Shallow mount: 6 x 6 x 2 ft (183 x 183 x 61 cm), 4,000 psi concrete or (CO + 8 ft) x 6 x 1 ft ((CO +244 cm) x 183 x 30.5 cm), 5,000 psi concrete. Deep mount: 4 x 4 x 4 ft (122 x 122 x 122 cm) 4,000 psi concrete. #5 rebar, grade 60.	6 x 6 x 4 ft (183 x 183 x 122 cm) 4,000 psi concrete, #6 rebar, grade 60	Shallow mount: 6 x 6 x 2 ft (183 x 183 x 61 cm), 4,000 psi concrete or (CO + 8 ft) x 6 x 1 ft ((CO +244 cm) x 183 x 30.5 cm), 5,000 psi concrete. Deep mount: 4 x 4 x 4 ft (122 x 122 x 122 cm) 4,000 psi concrete. #5 rebar, grade 60.	6 x 6 x 4 ft (183 x 183 x 122 cm) 4,000 psi concrete, #6 rebar, grade 60
Electrical Certification	Control panel certified to UL 508A by ETL		—	
Warranty	5 year w/product registration		5 year w/product registration	

UPS Battery Backup Power***

AC Power Supply with HyInverter AC***	StrongArm M30 AC Power Supply with HyInverter AC	StrongArm M50 AC Power Supply with HyInverter AC	—
---------------------------------------	--	--	---

Additional Model

CE Certification	StrongArm M30 CE	StrongArm M50 CE	—
------------------	------------------	------------------	---

* P1 and P2 rated for 12 ft clear opening. StrongArm M50 received a P2 rating with penetration limited to 1.17 m. Contact HySecurity to receive a copy of the ASTM F2656-07 M30 or M50 Test Certification.

** ExtremeCycle option available

*** 208/230VAC, single-phase AC operators only. See AC Power Supply with HyInverter AC for more information.

The operator's normal duty cycle and the actual number of arm cycles available from battery depends upon arm length/weight, battery size, state of charge and health, ambient temperature, accessory power draw and frequency of arm cycles during power outage

Patented dual arm design U.S. Pat. No. 9,822,501 B2

Contact Information:

Visit support.hysecurity.com for installation manuals, replacement part instructions, part diagrams and more. Qualified HySecurity distributors are experienced and trained to assist in resolving installation problems. For the name of a qualified distributor near you, call HySecurity at 800-321-9947. *Before contacting your distributor or HySecurity Technical Support, obtain the serial number of your operator.