

Perimeter Security Solutions



Experienced
design and
specification
support



HySecurity has a track record spanning more than 35 years in securing critical infrastructure and essential assets with anti-terrorist barriers and industrial access control point solutions. HySecurity offers a range of products suitable for every market segment.

Industrial and HVM (anti-ram) operators share the following benefits:

- UPS battery backup standard or as an option
- Dual gate, sally port, or sequenced gate integration
- Easy system troubleshooting with onboard events log
- Real time system security alerts
- Controls that lead the industry in versatility and capability
- 5 year warranty on all industrial and anti-ram crash hydraulic operators



Anti-Ram

HydraWedge™ SM50

Premium anti-ram wedge barrier

- 3 Crash Certifications: ASTM F2656-15 M50-P1, IWA14-1: 2013, PAS 68: 2013 (with NO vehicle penetration)
- Thousands of cycles per day. 3 second open, 1 second EFO
- Fast, two-day installation. Small footprint, small concrete foundation, 12 inch shallow mount and minimal rebar. Easy access to hydraulics
- Sites: Oklahoma City Arena, Financial Institutions, Juvenile Justice Center

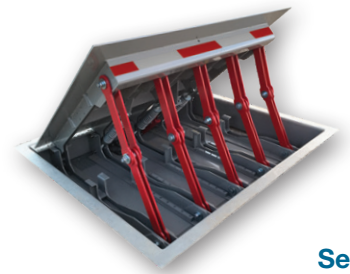

[See video](#)

StrongArm® M30/M50

Premium anti-ram barrier arm operator

- StrongArm M30 and M50 barrier arms stop a 15,000 lb truck driving 30 mph (and 50 mph respectively) in its tracks. M30 is P1 rated, M50 is P2 rated.
- Dual arm design prevents a large truck or a small passenger vehicle from breaching the security perimeter
- Bright LED arm lighting increases visibility
- Sites: McCormick Convention Center, Phoenix Sky Harbor Airport, Venetian Hotel, Dulles Airport, Cook County Juvenile Detention Center



[See video](#)

WedgeSmart™ DC

Parking wedge operator with barrier arm

- UPS battery backup crash wedge with parking barrier arm operator
- Crash-engineered FS30 stops a full-size sedan traveling at 30 mph
- Surface mount – easy and quick to install.
- Sites: Avis, State Street Bank, Cuyahoga County Justice Center, Social Security Administration



[See video](#)

Bollards

Solutions for your entire perimeter

- M30/M50 rated
- Deep or shallow mount, fixed or removable
- Choose your finish, lights and cover options
- Sites: Government facilities, educational facilities, retail centers, stadiums, airports, data centers, hospitals, parks



Anti-Ram

StrongSlide™ M30

Industry's longest crash tested clear opening (24ft)

- Crash Certification: ASTM F2656-20 M30. M30 is P1 rated, M50 is P2 rated
- Superior gate mechanics. Easier to install. Designed for a service life of 500,000 cycles
- Steel frame cantilever gate panel with bottom track hardware

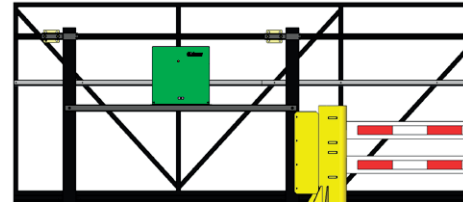

[See video](#)

Industrial

SlideDriver™ II

Maximum security combined with extreme durability

- Move up to 20,000 lb. Models: SD15, SD40, SD50F, SD80V, SD200V
- Fast Model SD50F will cycle gates up to 5,000 lb at 3ft/sec
- Tough: Secure steel chassis and tamper resistant cover. Wide temperature range without heater
- Integrated primary/secondary controls and preprogrammed relay settings
- Remote monitoring and management using onboard HyNet(TM) technology



StrongArm®

Premium industrial barrier arm operator

- Very long arms from 10 - 36 ft long. Open speed: 2 - 8 seconds (depending on arm length)
- Full 90° opening prevents tall vehicles from clipping the arm
- 14F fast model with breakaway arm bracket and kill switch
- Department of Transportation model with breakaway arm bracket
- Sites: Kansas City Airport, Minnesota DOT, Curacao International Airport, Bank One Corporate, Federal Aviation Administration, Pfizer, US Department of State, Texas A&M University, New Jersey Turnpike



[See video](#)

HydraSwing™

Premium industrial linear actuator

- Ideal for large, heavy swing gates up to 40 ft/15,000 lb
- Recommended for swing gates subject to extreme peak winds
- 10 - 30 second to open/close
- Graceful, smooth swing
- Sites: Ultimate Fighting Championship (UFC), BMW Manufacturing, Sacramento Regional County Sanitation, San Diego Zoo



[See video](#)

SwingRiser™

Premium industrial swing gate operator

- Move up 16 ft/3,000 lb gate leaf. Single and dual leaf operations
- Raises gates a full 12 inches during open cycle, to overcome curbs, road inclines or snow
- Optional locking pin mechanically locks when gate gently lowers at end of its cycle, for increased security
- Sites: Pentagon, US Embassy, Everett Police Precinct, Border Patrol, PBS, Long Beach Courthouse



[See video](#)

Commercial

Five year warranty (7 year for residential applications), 2 year warranty on StrongArmPark DC, 3 year warranty on MBAR/LBAR, with product registration.

SwingSmart™ DC

Commercial swing gate operator

- Move up to 40 ft/1,500 lb gate
- Synchronizes dual gates automatically, with ease
- Keeps gates moving after power loss up to 300 cycles with standard batteries, or up to 1,200 cycles with HySecurity Extended Battery Backup Kit
- Patented Taper Clamp provides adjustable protection from high winds and gate strikes
- Intelligent charging system monitors battery condition to maximize battery life
- Sites: Yale Mechanical Minneapolis MN, Mountain Lodge Texas, Fish & Wildlife Service WA, Denver Public Works Utilities Colorado, Garden Ridge Police Department Texas



[See video](#)

SlideSmart™ HD

Commercial slide gate operator

- Up to 4,000 ft travel on standard batteries (included) and 25,000 ft on extended batteries*
- Move up to 50 ft/3,000 lb gate
- Embedded Ethernet technology provides remote management capabilities
- SmartCNX installer smartphone app for full control from your phone
- Pad or post mount
- Sites: Storage facilities, Hertz Investment, Coca-Cola, U-Haul Moving, American Water, Riverview Towers



[See video](#)

SlideSmart™ DC

Commercial slide gate operator with battery backup

- Moves gates up to 40ft/1,500 lb gate
- Battery backup provides up to 4,000 ft of travel. Upgrade batteries for up to 25,000 ft. Monitor battery conditions and maximize life with the intelligent charging system
- Over 70 user configurable settings to meet site-specific requirements
- Easy system troubleshooting onboard event log
- Independent, field-adjustable open and close speeds
- Sites: American Water New Jersey, Aviation, In-N-Out Burger, Seattle WA Public Utilities, Uhaul, Corrections, State Colorado State Patrol



[See video](#)

StrongArmPark™ DC

Parking barrier arm operator

- Highly visible LED lit, straight aluminum arms, 8 to 14 ft and articulating arms, 8 and 10 ft
- In case of vehicle strike, arm breaks away and arm motion stops, protecting pedestrians, facility and operator/arm
- Accurate vehicle counts (transient, monthly, special, and available)
- Easily integrates with both large and small-scale revenue control systems
- Sites: Doug Fox Parking, Ohio State University, CSX Railroad, ACT Retirement Communities, San Marcos Regional Airport, Wichita State University, VISA



[See video](#)

MBAR/LBAR

Road access control

- Long arms from 8 to 29 ft
- Fast, smooth motion control
- Obstacle detection reverses arm on contact
- Energy saving: automatically switches to standby mode when idle to reduce consumption
- Sites: Retail centers, business parks

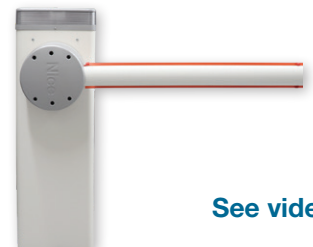

[See video](#)

HySecurity Accessories

Give yourself the EDGE

An ASO edge. These highly engineered, simple and rugged edge sensors give installers and their customers peace of mind. They're incredibly easy to install, withstand typical rough shipment and installation handling, don't short due to water absorption, and they keep performing under the most severe climate and site conditions.



[See ASO Intro video at vimeo](#)
[View spec sheet](#)

Photo Eye Kits

When safety is a priority, photo eyes are the solution. Detect pedestrians or cars before they become entrapped.



Add 8 User Relays to your HySecurity Operator

The customized Hy8Relay™ module provides eight additional user relays for integration with HySecurity's intelligent Smart Touch and Smart DC Controllers. Simple installation and direct communication expands the number of user relay functions available for all Smart Touch and Smart DC controllers with up-to-date software.



[View spec sheet](#)

Make Loop Problems Go Away with Hy5B™

The Power of Coordination. What if the vehicle detector and the gate operator could communicate? What would they say? It turns out there's lots to talk about.

Hy5B works in conjunction with the Smart Touch and Smart DC controllers on SWING AND SLIDE gates to share information, resulting in the most advanced vehicle detector ever.



[View spec sheet](#)

Operate heavy gates more reliably in severe weather

The XtremeDrive™ System comes standard with SlideDriver 80 and 200 and is optional with all models. The cogged lower wheel engages a matching cogged rack and increases traction the entire length of drive rail under the worst conditions. The XtremeDrive System provides maximum pull force and traction for exceptionally hard to move gates.*

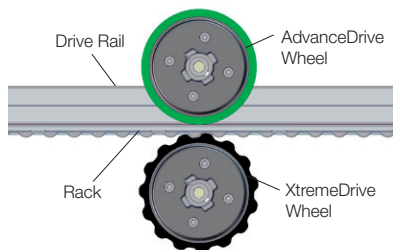

[*View spec sheet](#)



Recommended External Entrapment Protection Sensors List

The following sensors have been tested with Nice | HySecurity gate operators by an independent laboratory and certified to comply with UL 325 7th Edition. Select sensors from this list for UL compliant gate automation solutions. Contact the sensor manufacturer for specific recommendations for use.

Recommended Sensors				Compatible Control Boards					
	Mfg. Part # or Model	Brand	Nice Hysecurity Part #	Max Range	Smart Touch	Smart DC	Smart-Touch 725	1050	Mercury 310
Photo Eyes (Retro-reflective)	E3K-R10K4-NR-1	Omron	MX000999	40 ft	•	•	•		
	NIR-50-325	EMX	-	45 ft	•	•	•	•	•
	IRB-RET	EMX	-	53 ft	•	•	•	•	•
	IRB-RET2	EMX	-	53 ft	•	•	•	•	•
	E-931-S50RRGQ	Seco-Larm	-	46 ft	•	•	•		•
Photo Eyes (Thru-Beam)	Blue Bus Era Photo Eyes	Nice HySecurity	EPMB/A EPMOB/A EPLOB/A EPMAB/A EMBORB/A	45 ft			•	•	•
	OVS-50TNR	Optex	-	33 ft	•	•			
	IRB-MON	EMX	MX3990	65 ft	•	•	•		•
	IRB-MON2*	EMX	MX5792-01	65 ft	•	•	•		•
	E-960-D90GQ	Seco-Larm	-	90 ft	•	•	•		•
Edge Sensors	Sentir Series**	ASO Safety	"AS1502-* AS1501-**"	-	•	•	•	•	•
	CPT Models	Miller Edge	-	-	•	•	•	•	•
Edge Sensor Converters	Hy2NC (Converts 10K to NC Monitoring)	HySecurity	MX4018	-	•	•			
	GEM103 (Converts 10K to Pulsed Monitoring)	Miller Edge	-	-				•	
Edge Wireless Kits	iGAZE RE Kit	Transmitter Solutions	-	-	•	•	•	•	•
	WEL-200	EMX	-	-	•	•	•	•	•
	RB-G-K10C	Miller Edge	-	-	•	•	•	•	•
Multi-Input Module	The Solution – MIM-62	Miller Edge	-	-	•	•	•		•

*IRB-MON2 photo eyes are pre-bundled with HySecurity SwingSmart DC, SlideSmart DC and SlideDriver operators.

**Sentir Series ASO edge sensors are pre-bundled with HySecurity SlideSmart DC, SlideSmart CNX and SlideDriver operators.

UL 325 Standard:

- The operator shall monitor for the presence of every device at least once during each open and close cycle (32.1.8)
- It shall not be possible to make simple modifications in the field by adding, suppressing or changing, either on the operator or external entrapment protection device(s), to bypass, interfere with, or otherwise defeat the monitoring function. (32.1.10)
- Entrapment zones are now defined for each gate type (4.23, 4.24, 4.29, 4.34)

Slide Gates: To enable fully automatic operation, all SLIDE gate operators will require a minimum of TWO monitored external entrapment protection sensors (one for each direction) to protect entrapment zones in both the open and close direction of travel.

Preferred solution for slide gates: A photo eye for the close direction and a hard-wired edge sensor for the open direction that is mounted to the face of the leading post of the fence behind the gate. (Reach through injuries are the most common hazard associated with automatic sliding gates)

Swing Gates: To enable fully automatic operation, all SWING gate operators will require a minimum of ONE monitored external entrapment protection sensor to protect entrapment zones in either the open or close direction of travel. However, an additional monitored sensor is required if there is a risk of entrapment in both directions of gate travel.

Preferred solution for swing gates: A photo eye for the close direction and/or a hard-wired wraparound edge sensor on the leading edge of the gate, which protects for both directions of gate travel.

**Installers must assess each specific site and
install sensors that protect all potential entrapment zones**
For more information visit Gate Safety or see latest operator manuals at support.hysecurity.com

Swing Gate Common Entrapment Zones

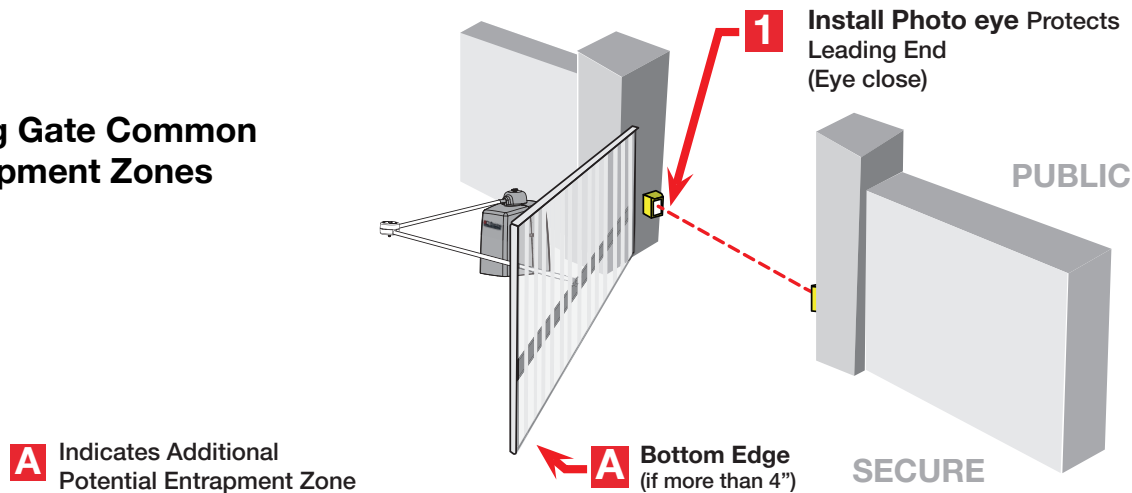

Slide Gate Common Entrapment Zones

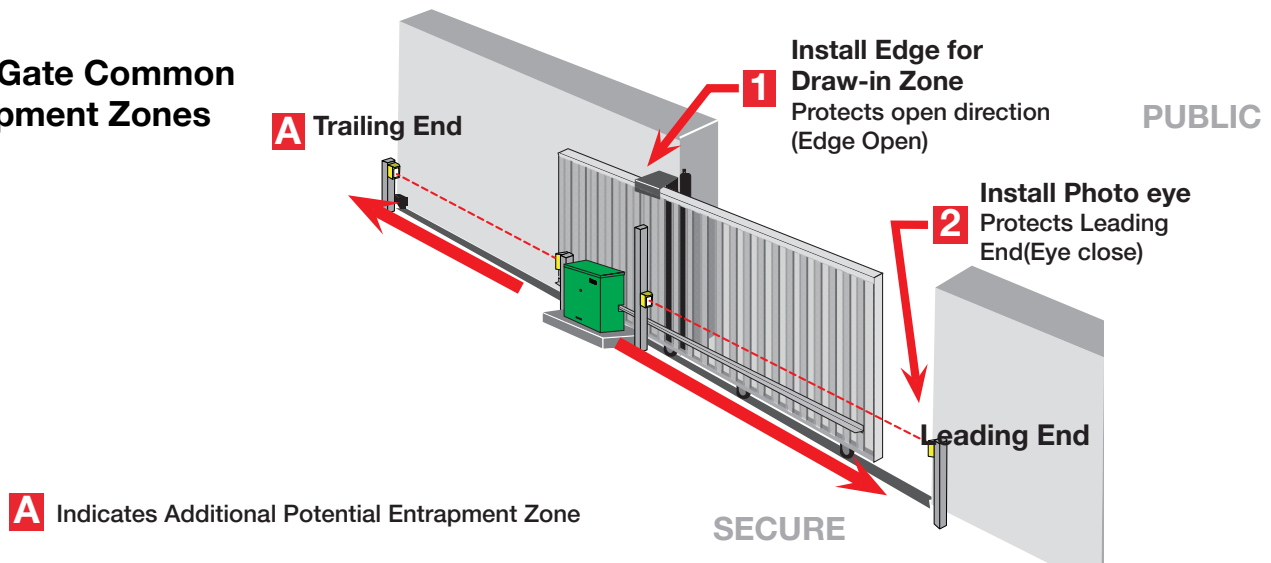

Get Specification Design Support

These highly experienced specification professionals save you time by helping you identify what components your project needs, then recommending latest technology and best solutions for you and your client. As Certified Automatic Gate System Designers, their years of hard won experience and knowledge will guide you through industry safety standards to help ensure your project's compliance. Their total immersion in this dynamic and growing industry safeguards your project's design and execution success.

Schedule an AIA CES approved lunch and learn with a specification engineer today.



Nikki Dinnel, CAGOI, CAGSD
Specification Sales Engineer
Central Region

Gate system design and consultation
nikki.dinnel@niceforyou.com
210-842-6445



Brad Richards, CAGSD
Specification Sales Manager
Western Region

Gate system design and consultation
brad.richards@niceforyou.com
206-491-9207

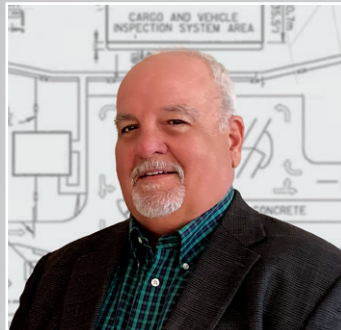

David Whortan, CAGSD
Specification Sales Engineer
Eastern Region

Gate system design and consultation
david.whortan@niceforyou.com
980-406-7789



Gül Gözüyılmaz
Specification Sales Manager
International

Gate system design and consultation
g.gozuyilmaz@niceforyou.com
+90 533-384-3220

Resources

- **Gate Safety:** UL 325 7th Edition technical overview, resource docs and webinar.
Visit hysecurity.com/gatesafety
- **DASMA Technical Data:** Selected links to DASMA technical data sheets.
Visit hysecurity.com/gatesafety/gate-safety-dasma
- **HySecurity.com:** Installation manuals, parts diagrams, specifications, product literature, image gallery, videos, training and more
- **Videos:** Product and training videos. Visit youtube.com/user/hysecurityvideos



Data Center



Commercial



United Nations



Pedestrian Zone



Car Rental



StrongSlide M30



HOA

HySecurity
a Nice brand
support.hysecurity.com

Nice/HySecurity is an industry leader of automated gate and perimeter security solutions. The HySecurity brand provides high-quality, ultra-reliable industrial gate operators and crash-rated Hostile Vehicle Mitigation (HVM) vehicle barriers designed to secure and protect critical infrastructure and facilities worldwide.

niceforyou.com

